

SONY®

Click 

“Handycam” Handbook NEX-VG20E/VG20EH



Table of Contents

Search Image

Index

HANDYCAM®

Using the “Handycam” Handbook

You will find information on using your camcorder to its fullest in this “Handycam” Handbook. Read the “Handycam” Handbook in addition to the Operating Guide (a separate volume). Information on using your camcorder connected to a computer will be also found in the Operating Guide and the “PMB Help” that is the Help of the supplied “PMB (Picture Motion Browser)” software.

Searching for information quickly

Click an item on the right edge of each page, and you will jump to the page for that item.

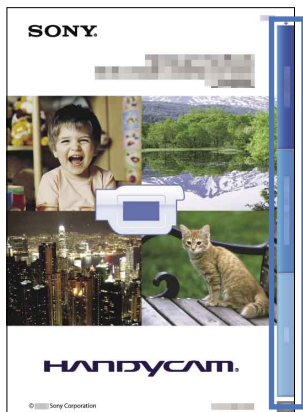

← Click here.

- You can search for an item by keyword using Adobe Reader. Refer to the Help of Adobe Reader for tips on how to use Adobe Reader.
- You can print out the “Handycam” Handbook.

Read this first

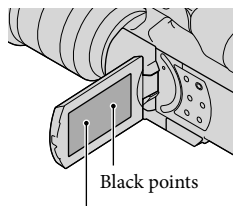

Using the camcorder

- Do not hold the camcorder by the following parts, and also do not hold the camcorder by the jack covers.

Viewfinder

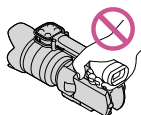

LCD Screen

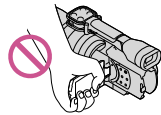

Lens (NEX-VG20EH)

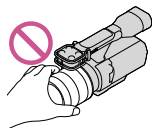

Lens hood (NEX-VG20EH)

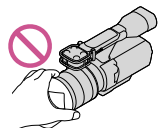

Built-in microphone

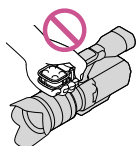

- The camcorder is not dustproofed, dripproofed or waterproofed. See "About handling of your camcorder" (p. 103).

Menu items, LCD panel, viewfinder and lens

- A menu item that is grayed out is not available under the current recording or playback conditions.
- The LCD screen and viewfinder are manufactured using extremely high-precision technology, so over 99.99% of the pixels are operational for effective use. However, there may be some tiny black points and/or bright points (white, red, blue, or green in color) that appear constantly on the LCD screen. These points are normal results of the manufacturing process and do not affect the recording in any way.

White, red, blue or green points

- Do not record the sun or leave the camcorder under the sun for a long time. The inside of the camcorder may be damaged. If sunlight is focused on a nearby object, it may cause a fire. When you must place the camcorder under direct sunlight, attach the lens cap.
- Exposing the LCD screen, the viewfinder or the lens to direct sunlight for long periods of time may cause malfunctions.
- Do not aim at the sun. Doing so might cause your camcorder to malfunction. Take images of the sun only in low light conditions, such as at dusk.
- Do not look at the sun or a strong light through a removed lens. This may cause irrecoverable damage to your eyes.

About language setting

- The on-screen displays in each local language are used for illustrating the operating procedures. Change the screen language before using the camcorder if necessary (p. 24).

On recording

- To ensure stable operation of the memory card, it is recommended to format the memory card with your camcorder before the first use (p. 82). Formatting the memory card will erase all the data stored on it and the data will be irrecoverable. Save your important data on your PC etc.
- Before starting to record, test the recording function to make sure the image and sound are recorded without any problems.
- Compensation for the contents of recordings cannot be provided, even if recording or playback is not possible due to a malfunction of the camcorder, memory card, etc.
- TV color systems differ depending on the country/region. To view your recordings on a TV, you need a PAL system-based TV.

- Television programs, films, video tapes, and other materials may be copyrighted. Unauthorized recording of such materials may be contrary to the copyright laws.
- Use the camcorder in accordance with local regulations.

Notes on playing back

- You may not be able to play back normally images recorded on your camcorder with other devices. Also, you may not be able to play back images recorded on other devices with your camcorder.
- Standard (STD) image quality movies recorded on SD memory cards cannot be played on AV equipment of other manufacturers.

DVD media recorded with HD image quality (high definition)

- DVD media recorded with high definition image quality (HD) can be played back with devices that are compatible with the AVCHD standard. You cannot play discs recorded with high definition image quality (HD) with DVD players/recorders as they are not compatible with the AVCHD format. If you insert a disc recorded with the AVCHD format (high definition image quality (HD)) into a DVD player/recorder, you may not be able to eject the disc.

Save all your recorded image data

- To prevent your image data from being lost, save all your recorded images on external media periodically. To save images on your computer, see page 53, and to save images on external devices, see page 61.
- The type of discs or media on which the images can be saved depend on the [ REC Mode] selected when the images were recorded. Movies recorded in [50p Quality **PS**] or [Highest Quality **FX**] can be saved on external media or on Blu-ray discs (p. 58, 61).

Notes on battery pack/AC Adaptor

- Be sure to remove the battery pack or the AC Adaptor after turning off the camcorder.
- Disconnect the AC Adaptor from the camcorder, holding both the camcorder and the DC plug.

Note on the camcorder/battery pack temperature

- When the temperature of the camcorder or battery pack becomes extremely high or extremely low, you may not be able to record or play back on the camcorder, due to the protection features of the camcorder being activated in such situations. In this case, an indicator appears on the LCD screen (p. 94) or on the viewfinder.

When the camcorder is connected to a computer or accessories

- Do not try to format the memory card of the camcorder using a computer. If you do so, your camcorder may not operate correctly.
- When connecting the camcorder to another device with communication cables, be sure to insert the connector plug in the correct way. Pushing the plug forcibly into the terminal will damage the terminal and may result in a malfunction of the camcorder.

If you cannot record/play back images, perform [Format]

- If you repeat recording/deleting images for a long time, fragmentation of data occurs on the memory card. Images cannot be saved or recorded. In such a case, save your images on some type of external media first, and then perform [Format] by touching **MENU** (MENU) → [Setup] → [ Media Settings] → [Format] → **OK** → **OK**.

Notes on optional accessories



- We recommend using genuine Sony accessories.
- Genuine Sony accessories may not be available in some countries/regions.

About this manual, illustrations and on-screen displays

- The example images used in this manual for illustration purposes are captured using a digital still camera, and therefore may appear different from images and screen indicators that actually appear on your camcorder. And, the illustrations of your camcorder and its screen indication are exaggerated or simplified for understandability.

- In this manual, the DVD disc recorded with high definition image quality (HD) is called AVCHD recording disc.
- Design and specifications of your camcorder and accessories are subject to change without notice.

Notes on use

- Do not do any of the following. Otherwise, the memory card may be damaged, recorded images may be impossible to play back or may be lost, or other malfunctions could occur.
 - ejecting the memory card when the access lamp (p. 28) is lit or flashing
 - removing the battery pack or AC Adaptor from the camcorder, or applying mechanical shock or vibration to the camcorder when the  (Movie)/ (Photo) lamps (p. 31) or the access lamp (p. 28) are lit or flashing
- When using a shoulder belt (sold separately), do not crash the camcorder against an object.

Features of this unit

The large-sized image sensor

The camcorder is equipped with an APS-C-sized (23.5 mm × 15.6 mm) CMOS image sensor.

Its sensor area is about 20 times as large as the 1/3-inch image sensor that is often used in existing video cameras.

The larger the image sensor, the shallower the depth of field. This allows you to reduce the focus on the background in order to make the subject stand out.

Interchangeable lens system

The camcorder employs the E-mount system for interchangeable lenses developed by Sony.

The E-mount lens supplied with the NEX-VG20EH has an optical camera-shake compensation mechanism (Active mode), and can also zoom up to 11 times.

Using a Mount Adaptor (sold separately) enables you to use a lenses (A-mount lenses) as well. You can choose the right lens for the recording conditions or subjects. A wide variety of characteristic lenses will widen visual expression.

Manual operability

The camcorder allows you to use aperture priority/shutter speed priority/full-manual exposure compensation, and adjust gain, white balance, etc. for recording movies.

The MANUAL dial and dedicated buttons are provided to enable you to use the camcorder in your own way, more comfortably.

High-performance microphone

The camcorder adopts an array microphone system that has a four-capsule structure.

The camcorder creates the correct sound localization by processing the signal from the microphone, achieves both realistic sensation and front localization, and records low-noise and clear sound. The high-performance microphone will make high-definition movies more appealing.

Search image

Shooting movies as clear as still images



Defocusing the background (46)



Adjusting the color (72)

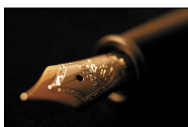

Focusing manually (41)



In better brightness (73)



Shooting like film image (80)

Shooting when holding the camcorder by hand



Preventing camera shake (76)



Following a moving subject (75)



Shooting in low angle (45)

Recording the sound clearly



Recording the surround sound (44)



Recording the loud noise naturally (78)

Shooting landscapes



The sky in vivid colors (73)



Keeping your shot level (78)

Shooting clear still images



The same scene with different brightness (75)



Capturing the best moment (75)

Table of contents

Using the "Handycam" Handbook	2
Searching for information quickly	2
Read this first	3
Notes on use	5
Features of this unit	6
Search image	7

Getting Started

Step 1: Checking supplied items	12
All models	12
NEX-VG20EH	13
Step 2: Attaching the supplied accessories	14
Attaching the lens	14
Attaching the Wind Screen	14
Attaching the battery cover	14
Step 3: Charging the battery pack	15
Step 4: Attaching the lens	18
Removing the lens	20
Step 5: Turning the power on, and setting the date and time	23
Changing the language setting	24
Step 6: Making setting adjustments before recording	25
The LCD panel	25
Changing the display on the LCD screen	25
The viewfinder	26
Step 7: Inserting a memory card	28

Recording/Playback

Recording	30
Recording movies	31
Shooting photos	32
Playback on the camcorder	34
Operating the camcorder while playing a movie	36
Viewing photos	37
Playing images on a TV	38
List of connection	38
Using "BRAVIA" Sync	40

Advanced operations

Useful functions for recording movies and photos	41
Zooming.....	41
Adjusting the focus manually	41
Using the expanded focus	42
Selecting high definition image quality (HD) or standard image quality (STD)	42
Selecting the recording mode	43
Using the Tracking focus function.....	44
Recording sound with more presence (5.1ch surround recording).....	44
Recording in mirror mode	45
Recording at a different angle	45
Adjusting manually.....	46
Controlling the image settings manually with the MANUAL dial	46
Adjusting the IRIS.....	46
Adjusting the Shutter Speed	47
Adjusting Exposure.....	47
Advanced manual operation	48
Making good use of your camcorder	50
Deleting movies and photos	50
Protecting recorded movies and photos (Protect).....	51
Dividing a movie.....	51
Capturing a photo from a movie	52





Saving movies and photos with a computer

Selecting the method for creating a disc (computer).....	53
Creating a disc with one touch (Disc Burn)	55
Importing movies and photos to a computer.....	56
Saving images on a disc	57

Saving images with an external device

Selecting a method for saving images with an external device	59
The devices on which the created disc can be played back.....	60
Saving images on an external media device	61
Saving desired movies and photos	62
Playing back images in the external media device on the camcorder.....	63
Creating a high definition image quality (HD) disc with such as a Sony DVD writer, etc.	64
Creating a standard definition image quality (STD) disc with a recorder, etc.	65

Customizing your camcorder

Using menus	67
Operating menus	67
Menu lists	68
 Shooting Mode (Items for selecting a shooting mode)	72
 Camera/Mic (Items for customized shooting)	72
 Image Quality/Size (Items for setting up image quality or size)	80
 Edit/Copy (Items for editing)	82
 Setup (Other setup items)	82

Additional information

 Troubleshooting	88
Self-diagnosis display/Warning indicators	94
Recording time of movies/number of recordable photos	97
Expected time of recording and playback with each battery pack	97
Expected recording time of movies	97
Expected number of recordable photos	98
Using your camcorder abroad	99
Maintenance and precautions	101
About the AVCHD format	101
About the memory card	101
About the "InfoLITHIUM" battery pack	102
About handling of your camcorder	103

Quick reference

Screen indicators	108
Parts and controls	110
Index	115

Step 1: Checking supplied items

Make sure that you have following items supplied with your camcorder. The numbers in () are the supplied quantity.

All models

- This camcorder (1)
- Body cap (attached to camcorder NEX-VG20E; supplied but not attached to other models) (1) (p. 18)

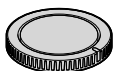

- AC Adaptor (1) (p. 15)

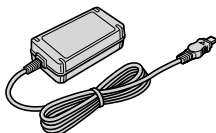

- Power cord (mains lead) (1) (p. 15)

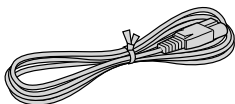

- Component A/V Cable (1) (p. 38)

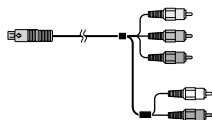

- A/V connecting cable (1) (p. 38)

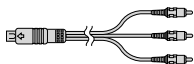

- USB cable (1) (p. 61)

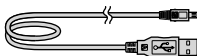

- Wireless Remote Commander (RMT-835) (1) (p. 113)

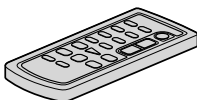

A button-type lithium battery is already installed.

- Rechargeable battery pack (NP-FV70) (1) (p. 15)

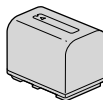

- Battery Cover (1) (p. 14)

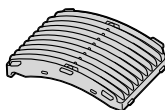

- Wind Screen (1) (p. 14)



- Large eyecup (1) (p. 27)



- CD-ROM “Handycam” Application Software (1)
 - “PMB” (Software, including “PMB Help”)
 - Image Data Converter (RAW development software)
 - “Handycam” Handbook (PDF)
- Operating Guide (1)

NEX-VG20EH

- Zoom lens (E 18-200mm F3.5-6.3 OSS) (attached to the camcorder) (1) (p. 18)

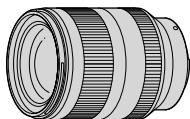

- Lens hood (1) (p. 22)



- Front lens cap (attached to the lens) (1) (p. 18)

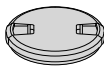

- Rear lens cap (1) (p. 18)



Step 2: Attaching the supplied accessories

Attaching the lens

See page 18 for information on attaching the lens. The NEX-VG20E does not come with the E 18-200mm F3.5-6.3 OSS lens. Please use appropriate lenses (sold separately).

For NEX-VG20EH models, the lens is attached to the camcorder at the time of purchase.

Attaching the Wind Screen

Use the Wind Screen when you want to reduce the wind noise recorded by the microphone. Attach the Wind Screen with the Sony logo facing down.

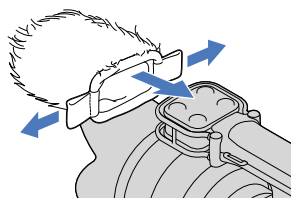

Attaching the battery cover

Attach the battery cover after attaching the battery pack.

Attach the battery cover with the projecting part (1) facing as shown in the illustration.

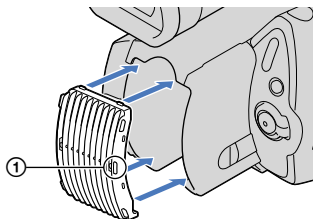

Step 3: Charging the battery pack

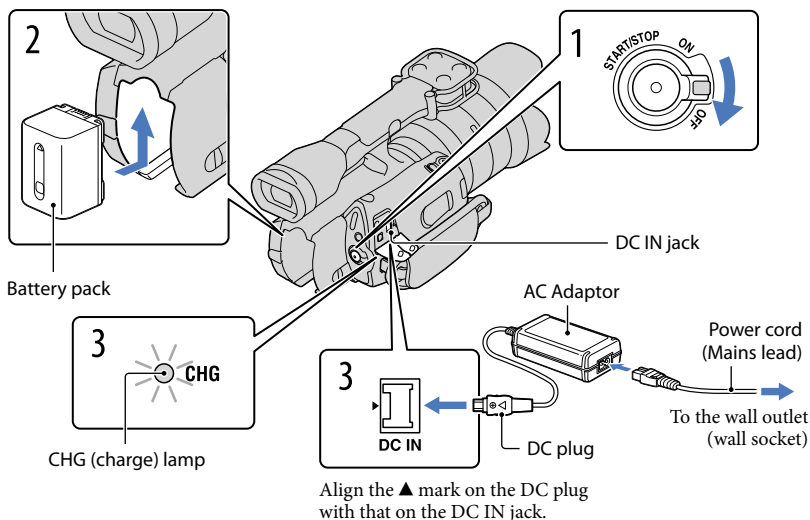

You can charge the “InfoLITHIUM” battery pack (V series) after attaching it to your camcorder.

⚡ Notes

- You cannot attach any “InfoLITHIUM” battery pack other than the V series to your camcorder.
- You cannot attach the “InfoLITHIUM” battery pack NP-FV30/FV50, even though they are V series.

- 1 Slide the POWER switch to OFF (the default setting).
- 2 Attach the battery pack by sliding it in the direction of the arrow until it clicks.
- 3 Connect the AC Adaptor and the power cord (mains lead) to your camcorder and the wall outlet (wall socket).

The CHG (charge) lamp lights up and charging starts. The CHG (charge) lamp turns off when the battery pack is fully charged.

4 When the battery is charged, disconnect the AC Adaptor from the DC IN jack of your camcorder.

Charging time

Approximate time (min.) required when you fully charge a fully discharged battery pack.

Battery pack	Charging time
NP-FV70 (supplied)	195
NP-FV100	390

- The charging times shown in the table above are measured when charging the camcorder at a temperature of 25 °C (77 °F). It is recommended that you charge the battery in a temperature range of 10 °C to 30 °C (50 °F to 86 °F).

Tips

- See page 97 on recording and playing time.
- When your camcorder is on, you can check the approximate amount of remaining battery power with the remaining battery indicator at the upper right on the LCD screen.

To remove the battery pack

Slide the POWER switch to OFF. Slide the BATT (battery) release lever (①) and remove the battery pack (②).

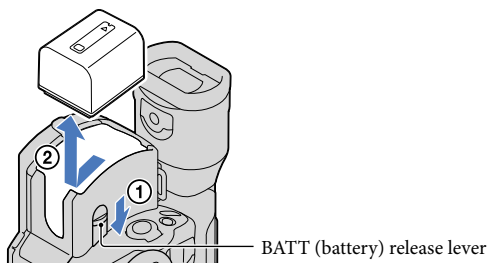

To use a wall outlet (wall socket) as a power source

Make the same connections as “Step 3: Charging the battery pack” (p. 15). Even if the battery pack is attached, the battery pack is not discharged.



Charging the battery pack abroad

You can charge the battery pack in any countries/regions using the AC Adaptor supplied with your camcorder within the AC 100 V - 240 V, 50 Hz/60 Hz range.

Notes

- Do not use an electronic voltage transformer.

Notes on the battery pack

- When you remove the battery pack or disconnect the AC Adaptor, turn the camcorder off and make sure that the  (Movie)/ (Photo) lamps (p. 31), the access lamp (p. 28) are turned off.
- The CHG (charge) lamp flashes during charging under the following conditions:
 - The battery pack is not attached correctly.
 - The battery pack is damaged.
 - The temperature of the battery pack is low.
Remove the battery pack from your camcorder and put it in a warm place.
 - The temperature of the battery pack is high.
Remove the battery pack from your camcorder and put it in a cool place.
- In the default setting, the power turns off automatically if you leave your camcorder without any operation for about 5 minutes, to save battery power ([A. Shut Off], p. 86).

Notes on the AC Adaptor

- Use the nearby wall outlet (wall socket) when using the AC Adaptor. Disconnect the AC Adaptor from the wall outlet (wall socket) immediately if any malfunction occurs while using your camcorder.
- Do not use the AC Adaptor placed in a narrow space, such as between a wall and furniture.
- Do not short-circuit the DC plug of the AC Adaptor or battery terminal with any metallic objects. This may cause a malfunction.

Note on the power cord (Mains lead)

The power cord (Mains lead) is designed specifically for use with this camcorder only, and should not be used with other electrical equipment.

Step 4: Attaching the lens

This manual explains how to attach a lens using the E 18-200mm F3.5-6.3 OSS lens that comes with NEX-VG20EH (the lens is attached to the camcorder at the time of purchase). If you use another lens, refer to the instruction manual supplied with that lens.

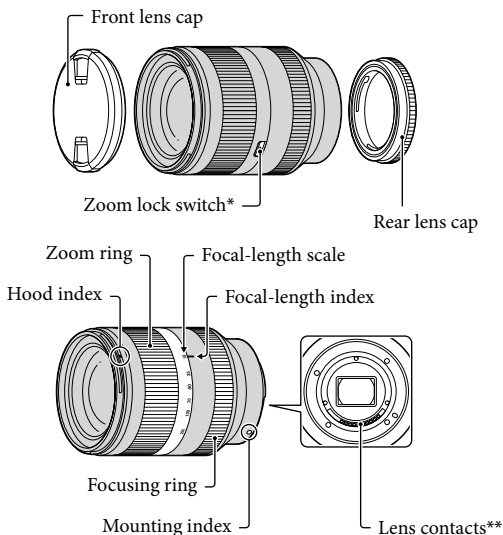

* This switch prevents the lens cylinder from being extended by its own weight when it is being transported, etc. Turn the zoom ring back toward the W-end, and slide the switch toward ▼ to lock it. To unlock it, set the switch to the original position.

**Do not touch or dirty the lens contacts.

- 1 Remove the body cap from the camcorder body and the packaging lid from the rear of the lens.

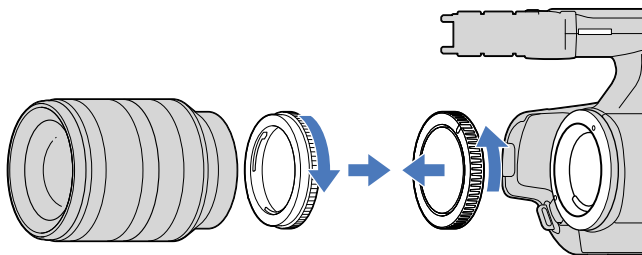

-
- 2** Mount the lens by aligning the mounting indexes (white) on the lens and the camcorder body. While pushing the lens lightly toward the camcorder body, turn the lens clockwise until it clicks into the locked position.

Be sure to put the lens on straight.

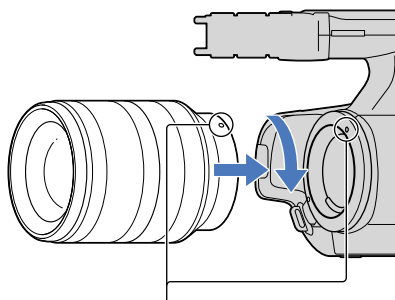

Mounting indexes (white)

Notes

- When attaching a lens, do not press the lens release button.
- Do not use force when attaching a lens. Mounting the lens forcibly may result in a malfunction or damage of the lens mount.
- There may be some slight movement of the lens in the locked position, depending on the lens used. This is not a malfunction.
- Hold the camcorder body with the front end downward, and quickly change the lens somewhere away from dusty locations so as to keep dust or debris from getting inside the camcorder body.

- 1 While pressing the lens release button all the way in, turn the lens counterclockwise until it stops.

- When you remove the lens, make sure that you hold both of the lens and the camcorder body.

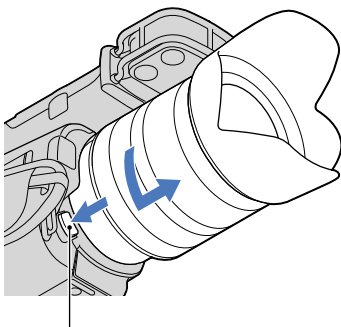

Lens release button

- 2 Replace the packaging lid on the lens and attach the body cap to the camcorder body.

- Align the mark on the body cap to the mounting indexes, and turn the cap clockwise.
- Before you attach caps, remove dust from them.

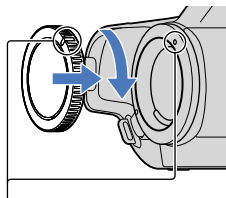

Align the marks.

⚡ Notes

- When changing the lens, if dust or debris gets inside the camcorder body and adheres to the surface of the image sensor (the part that acts as the film), it may appear on the image, depending on the shooting conditions. The image sensor is applied with the anti-dust coating, to prevent dust from adhering to the image sensor. However, attach or remove the lens quickly somewhere away from dusty locations.
- Do not leave the camcorder body with the lens and body cap removed.

If dust or debris adheres on the image sensor

Turn off the camcorder and detach the lens. Clean the image sensor and the surrounding area using a blower (sold separately), and then reattach the lens.

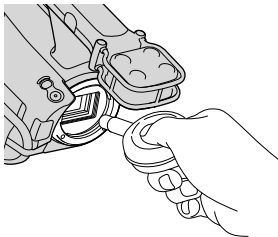

⚡ Notes

- Do not use a spray blower because it may scatter water droplets inside the camcorder body.
- Do not put the tip of a blower into the cavity beyond the mount, so that the tip of the blower does not touch the image sensor.
- Hold the camcorder's face downward to prevent the dust from resettling in the camcorder.
- Do not apply a mechanical shock to the camcorder during cleaning.
- If you cannot clean the image sensor by the above procedure, consult your Sony dealer or local authorized Sony service facility.

Mount Adaptor

Using a Mount Adaptor (sold separately), you can attach an A-mount lens (sold separately) to your camera. For details, refer to the operating instructions supplied with the Mount Adaptor.

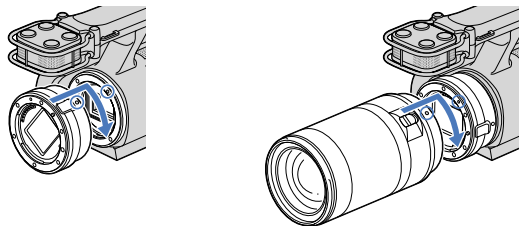

The available functions differ depending on the Mount Adaptor type.

Functions	LA-EA1	LA-EA2
Autofocus	Available with SAM/SSM lens only*	Available
AF system	Contrast AF	Phase-detection AF
AF/MF Select	Switchable on the lens	SAM/SSM lenses: switchable on the lens Other lenses: switchable on the FOCUS button
Autofocus Mode (Only photo mode)	Single	Single/Continuous

* With LA-EA1, autofocus speed with an A-mount lens attached will be slower compared to an E-mount lens. (When an A-mount lens is attached, the autofocus speed will be about 2 seconds to 7 seconds, when shooting under Sony measurement condition. The speed may vary depending on the subject, ambient light, etc.)

⚡ Notes

- Some lenses may not be usable or may have limited functionality. Check the dedicated support web site or consult your local authorized Sony service facility on compatible lenses.
- The sound of the lens and the camera in operation may be recorded during movie recording. You can avoid this by setting Audio Rec Level to minimum. Touch **MENU** (MENU) → [Camera/Mic] → [Microphone] → [Audio Rec Level].
- It may take a long time or may be difficult for the camera to focus, depending on the lens used or the subject.

To attach the lens hood

Align the red line of the lens hood to that of the lens and mount the lens hood on the lens. Turn the lens hood clockwise until the red dot of the lens hood and the red line of the lens align with a click.

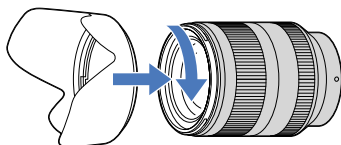

When storing the lens, fit the lens hood onto the lens backwards.

Step 5: Turning the power on, and setting the date and time

- 1 Slide the POWER switch to ON while pressing the green button.

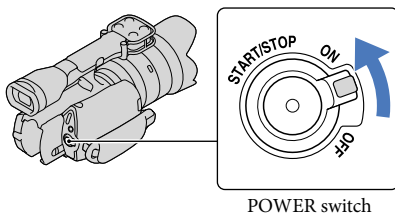

- 2 Select the desired language, then touch [Next].

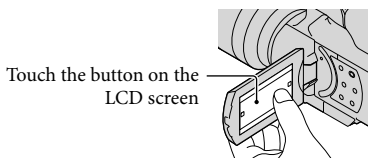

- 3 Select the desired geographical area with **<**/**>**, then touch [Next].

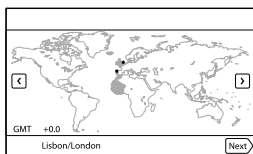

- To set the date and time again, touch **MENU** (MENU) → [Setup] → [⌚ (⌚ Clock Settings)] → [Date & Time Setting] → [Date & Time]. When an item is not on the screen, touch **^**/**v** until the item appears.

4 Set [Summer Time], then touch [Next].

- If you set [Summer Time] to [On], the clock advances 1 hour.

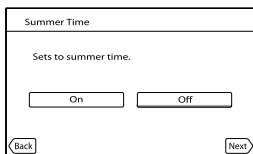

5 Select the date format, then touch [Next].

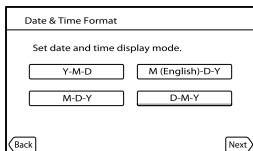

6 Select the date and time, touch \blacktriangle / \blacktriangledown to set the value, then touch [Next] \rightarrow **OK**.

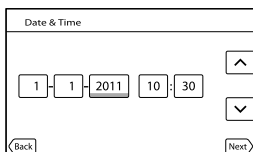

The clock starts.

⚡ Notes

- The date and time does not appear during recording, but they are automatically recorded on the memory card, and can be displayed during playback. To display the date and time, touch **MENU** (MENU) \rightarrow [Setup] \rightarrow [▶] (▶ Playback Settings) \rightarrow [Data Code] \rightarrow [Date/Time] \rightarrow **OK**.
- You can turn off the operation beeps by touching **MENU** (MENU) \rightarrow [Setup] \rightarrow [🔧] (🔧 General Settings) \rightarrow [Beep] \rightarrow [Off] \rightarrow **OK**.
- If the button you touch does not react correctly, calibrate the touch panel (p. 104).

To turn off the power

Slide the POWER switch to OFF.

The  (Movie) lamp flashes for a few seconds and the camcorder is turned off.

Changing the language setting

You can change the on-screen displays to show messages in a specified language.

Touch **MENU** (MENU) \rightarrow [Setup] \rightarrow [🔧] (🔧 General Settings) \rightarrow [Language Setting] \rightarrow a desired language \rightarrow **OK** \rightarrow **X** \rightarrow **X**.

Step 6: Making setting adjustments before recording

The LCD panel

Open the LCD panel 90 degrees to the camcorder (①), and then adjust the angle (②).

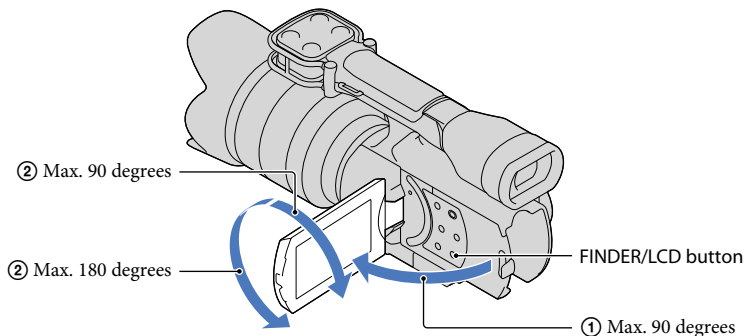

Tips

- Images are displayed on the viewfinder or the LCD screen.
- Press FINDER/LCD to select whether you want to display the image on the viewfinder or the LCD screen.
You can also select those display locations by opening or closing the LCD screen.
- FINDER/LCD enables you to use the viewfinder without closing the LCD panel, so you can operate buttons which are hidden when the LCD screen is closed.
- You can adjust the brightness of the LCD screen with [LCD Brightness] (p. 85).

Changing the display on the LCD screen

Press DISPLAY to cycle the screen display in the following order:

Recording: Detailed display → simple display → minimum display

Playing: Detailed display → minimum display

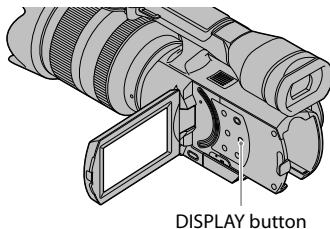

Tips

- In the default setting, the screen display changes to the simple display after about 4 seconds ([Display Setting], p. 86). The display changes to the detailed display when you touch anywhere on the screen except the buttons on the LCD screen so that you can use items.



The viewfinder

When you record while viewing through the viewfinder, close the LCD panel, or press FINDER/LCD (p. 111). If the indications in the viewfinder appear blurred, adjust the viewfinder lens adjustment lever located beneath the viewfinder.

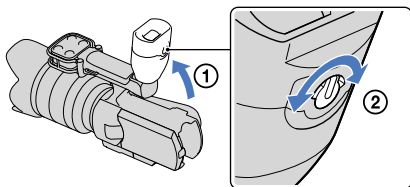

Notes

- You may see colors (red, blue, green) shimmering in the viewfinder when you move your line of sight. This is not a malfunction. The shimmering colors will not be recorded on the memory card.

Tips

- You can adjust the brightness of the viewfinder backlight from [VF Brightness] (p. 85).

If the image is not clear in the viewfinder

If you cannot see the picture in the viewfinder clearly under bright circumstances, use the supplied large eyecup. To attach the large eyecup, stretch it slightly and align it with the eyecup groove in the viewfinder. You can attach the large eyecup facing either the right or left side.

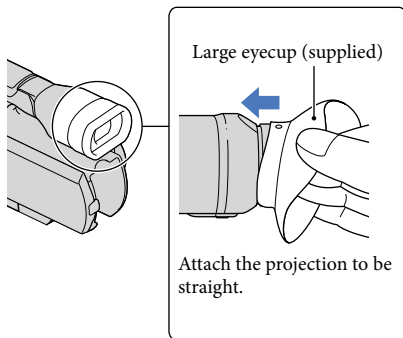

⚡ Notes

- Do not remove the pre-attached eyecup.

Step 7: Inserting a memory card

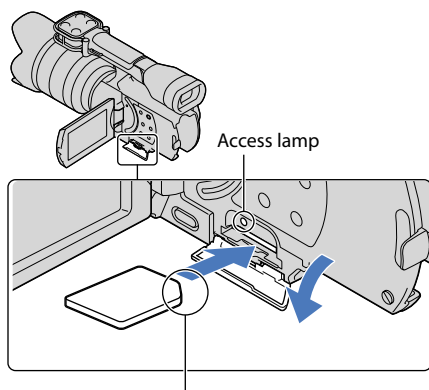

Note the direction of notched corner.

- 1 Open the cover, and insert the memory card with the notched edge in the direction as illustrated until it clicks.

The [Preparing image database file. Please wait.] screen appears if you insert a new memory card. Wait until the screen disappears.

- 2 Close the cover.



⚡ Notes

- If [Failed to create a new Image Database File. It may be possible that there is not enough free space.] is displayed, format the memory card (p. 82).
- Confirm the direction of the memory card. If you forcibly insert the memory card in the wrong direction, the memory card, memory card slot, or image data may be damaged.
- Do not open the cover during recording.
- When inserting or ejecting the memory card, be careful so that the memory card does not pop out and drop.

To eject the memory card

Open the cover and lightly push the memory card in once.

Types of memory card you can use with your camcorder

		SD Speed Class	Described in this manual
“Memory Stick PRO Duo” media (Mark2)		—	“Memory Stick PRO Duo” media
“Memory Stick PRO-HG Duo” media			
SD memory card		Class 4 or faster	SD card
SDHC memory card			
SDXC memory card			

- Operation with all memory cards is not assured.
- “Memory Stick PRO Duo” media, half the size of “Memory Stick”, or standard size SD cards can be used for this camcorder.
- Do not attach a label or the like on memory card or memory card adaptor. Doing so may cause a malfunction.
- “Memory Stick PRO Duo” media of up to 32 GB and SD cards of up to 64 GB have been verified to operate with your camcorder.

Notes

- A MultiMediaCard cannot be used with this camcorder.
- Movies recorded on SDXC memory cards cannot be imported to or played back on computers or AV devices not supporting the exFAT* file system by connecting the camcorder to these devices with the USB cable. Confirm in advance that the connecting equipment is supporting the exFAT system. If you connect an equipment not supporting the exFAT system and the format screen appears, do not perform the format. All the data recorded will be lost.

* The exFAT is a file system that is used for SDXC memory cards.

Recording

In the default setting, movies are recorded with high definition image quality (HD).

- 1 Fasten the grip belt.

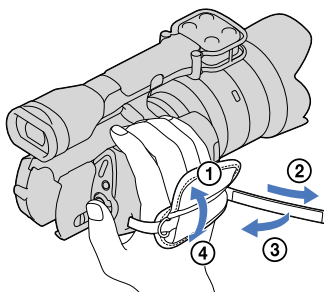

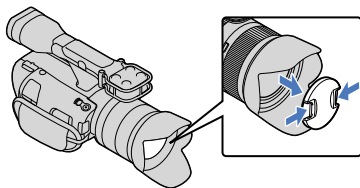

- 2 To remove the lens cap, push the sliders on both sides of the cap.



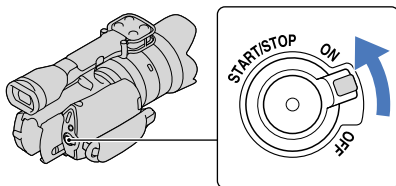

- 3 Slide the POWER switch to ON while pressing the green button.
Your camcorder is turned on.

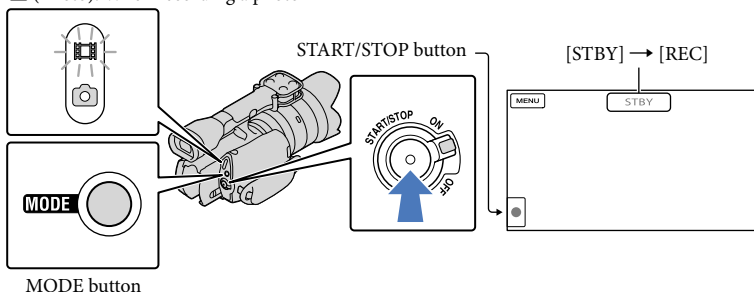

 (Movie): When recording a movie

 (Photo): When recording a photo



1 Press **MODE** to turn on the  (Movie) lamp.

2 Press **START/STOP** to start recording.



The recording lamp lights up during recording (p. 112).

To stop recording, press **START/STOP** again.

Notes

- The maximum continuous recordable time of movies is about 13 hours.
- When a movie file exceeds 2 GB, the next movie file is created automatically.
- It will take several seconds until you can start recording after you turn on the camcorder. You cannot operate your camcorder during this time.
- The following states will be indicated if data is still being written onto the recording media after recording has finished. During this time, do not apply shock or vibration to the camcorder, or remove the battery or AC Adaptor.
 - Access lamp (p. 28) is lit or flashing
 - The media icon in the upper right of the LCD screen is flashing
- The camcorder does not have a power zoom function.
- Hold the lens with your left hand to support the camera during recording (when you do not use a tripod). Make sure that your fingers are not touching the microphone.

Tips

- See page 97 on the recordable time of movies.
- The IRIS, Shutter Speed, Gain and Exposure are set to automatic adjustment when PROGRAM AE is pressed.
- [ SteadyShot] is set to [Standard] in the default setting. Note that if the attached lens does not have an image stabilizing feature, SteadyShot will not be usable.
- You can capture photos from recorded movies (p. 52).
- You can check the recordable time, estimated remaining capacity, etc., by touching **MENU** (MENU) → [Setup] → [ Media Settings] → [Media Info] (p. 82).

- The LCD screen of your camcorder can display recording images across the entire screen (full pixel display). However, this may cause slight trimming of the top, bottom, right and left edges of images when played back on a TV which is not compatible with full pixel display. In this case, set [Guide Frame] to [On] (p. 78), and record images using the outer frame displayed on the screen as a guide.

Data code during recording

The recording date, time and condition are recorded automatically on the memory card. They are not displayed during recording. However, you can check them as [Data Code] during playback. To display them, touch **MENU** (MENU) → [Setup] → [] ([] Playback Settings) → [Data Code] → a desired setting → **OK**.

Shooting photos

 (Movie): When recording a movie

 (Photo): When recording a photo

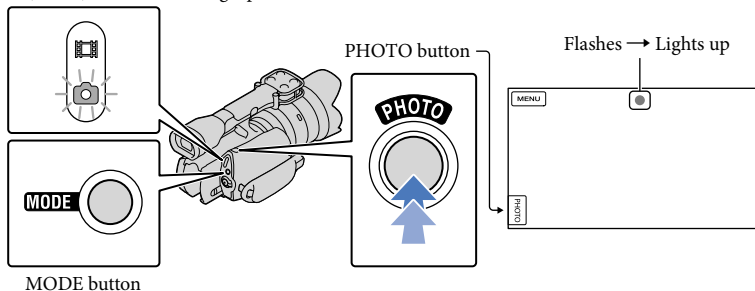

When  disappears, the photo is recorded.

1 Press MODE to turn on the (Photo) lamp.

The LCD screen display switches for photo recording mode.

2 Press PHOTO lightly to adjust the focus, then press it fully.



Focus indicator

The focus indicator shows the focusing status by lighting/flashing.

- lit : Focus locked.
- flashing : The camcorder cannot focus on the subject automatically. Either recompose the shot or change the focus setting.

Tips

- See page 98 on the recordable number of photos.
- The IRIS, Shutter Speed, ISO and Exposure are set to automatic adjustment when PROGRAM AE is pressed.

- To change the image size, touch **MENU** (MENU) → [Image Quality/Size] → [ Image Size] → a desired setting → **OK**.
- You cannot record photos while  is displayed.

Playback on the camcorder

Tips

- The camcorder displays recorded images as an event automatically based on the date and time.

1

Slide the POWER switch to ON while pressing the green button.

Your camcorder is turned on.

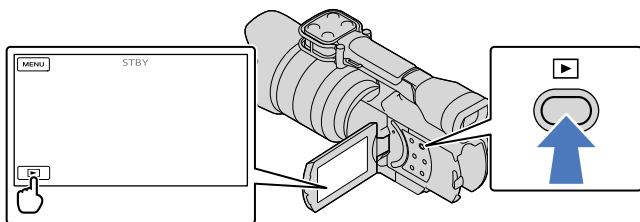

2

Press  (View Images).





The Event View screen appears after some seconds.

3

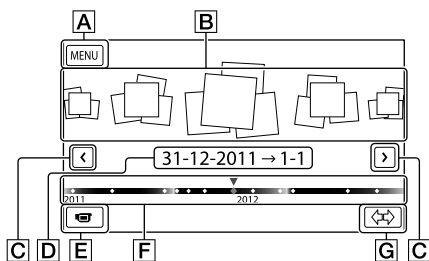
Touch  /  to select the desired event (B).



- A** To the MENU screen
- B** Events
- C**  /  : To the previous/next event
- D** Event name
- E** Change to the movie/photo recording mode
- F** Time-line bar
- G** Change Event Scale button

The Event Index screen appears when you touch the event that is displayed on the center.

- Touch  (**G** Change Event Scale) on the bottom right of the screen so that you can change the time range of the time-line bar from one and a half years to three months, which changes the number of the events that can be displayed on the time-line bar.

4 Touch an image you want to view.

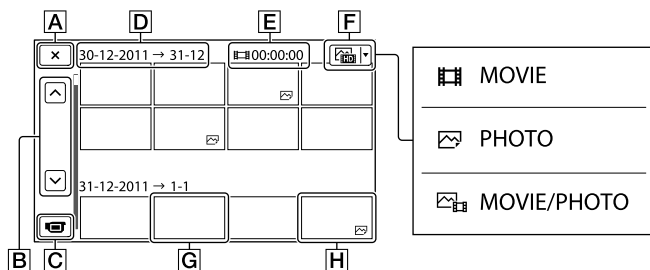

Touch **F** to select the image type to be displayed in the index from [**MOVIE**] (movies only), [**PHOTO**] (photos only), or [**MOVIE/PHOTO**] (movies and photos mixed).

A To go back to the Event View screen

B **^**/**v**: Displays the previous/next page (Touching and holding the button scrolls the index screen.)

C Change to the movie/photo recording mode

D Event title

E Total time of movies in the Event (The total number of still images is displayed when there are still images only)



F Switch Image Type button

G Movie

H Photo

- **▶** appears with the movie or photo that was most recently played or recorded. If you touch the movie or photo with **▶**, you can continue playback from the previous time.

Operating the camcorder while playing a movie

You can use the functions shown in the figure below while the camcorder is playing a movie. The figure below will be displayed when you select [ MOVIE/PHOTO] (the default setting) or [ MOVIE] by touching the Switch Image Type button on the Event Index screen.

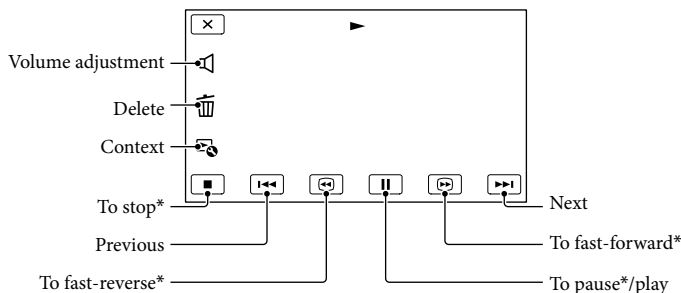







* These buttons can be used only when the camcorder is playing a movie.

⚡ Notes

- You may not be able to play back the images with other devices than camcorder.

💡 Tips

- Touching the  button on the playback screen displays functions you can currently use, and allows you to use those functions easily.
- When playback from the selected image reaches the last image, the screen returns to the INDEX screen.
- Touch  /  during pause to play back movies slowly.
- As you repeat touching  /  during playback, movies are played as fast as about 5 times → about 10 times → about 30 times → about 60 times.
- The recording date, time, and shooting conditions are recorded automatically during recording. This information is not displayed during recording, but you can display it during playback by touching **MENU** (MENU) → [Setup] → [ ( Playback Settings)] → [Data Code] → a desired setting → **OK** → **X**.

To adjust the sound volume of movies

While playing back movies, touch  → adjust with  /  → **OK**.

Viewing photos

You can use the functions shown in the figure below while you are viewing photos. The figure below will be displayed when you select [PHOTO] by touching the Switch Image Type button on the Event Index screen.

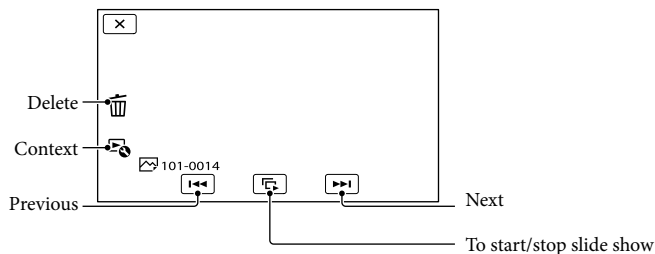

Tips

- To repeat Slideshow, touch [Slideshow Set].

Playing images on a TV

Connection methods and the image quality (high definition (HD) or standard definition (STD)) viewed on the TV screen differ depending on what type of TV is connected, and the connectors used. You can watch images on your TV screen even while they are being recorded.

Output connectors on the camcorder

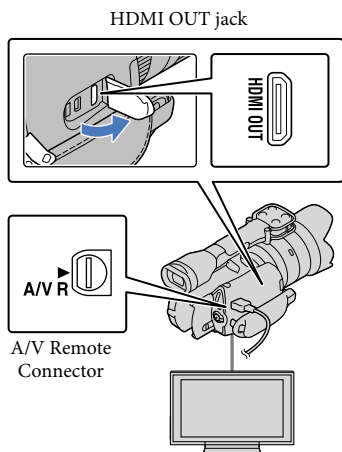

List of connection

Connecting to a high definition TV

When the recording quality is high definition image quality (HD), the movies are played back in high definition image quality (HD). When the recording quality is standard image quality (STD), the movies are played back in standard definition image quality (STD).

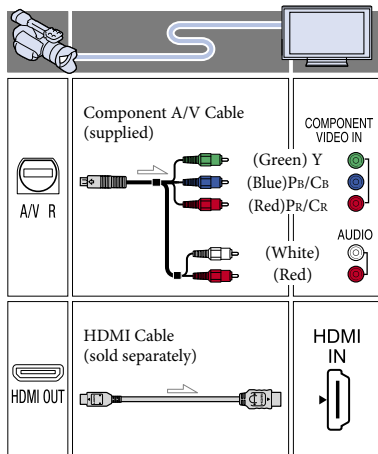

Connecting to a non-high-definition 16:9 (wide) or 4:3 TV

When movies are recorded with high definition image quality (HD), they are played back in standard definition image quality (STD). When movies are recorded with standard image quality (STD), they are played back in standard definition image quality (STD).

- 1 Switch the input on the TV to the connected jack.
 - Refer to the instruction manuals of the TV.
- 2 Connect the camcorder to a TV.
 - Use the supplied AC Adaptor as the power source (p. 16).
- 3 Play a movie or a photo on the camcorder (p. 34).

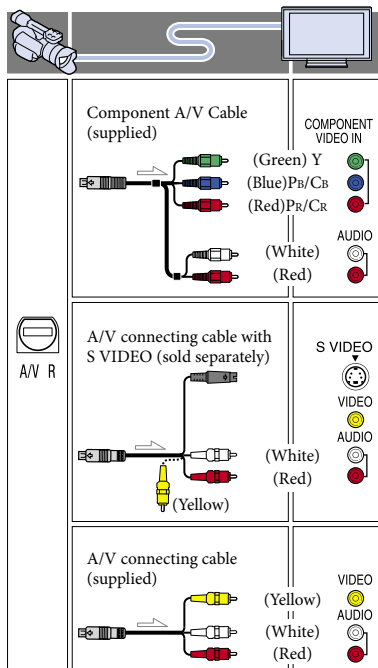

- Do not connect the camcorder HDMI OUT jack to an external device HDMI OUT jack, as malfunction may result.
- When the connected device is compatible with 5.1ch surround sound, high definition image quality (HD) movies are output in 5.1ch surround sound automatically. Standard definition image quality (STD) movies are converted to 2ch sound.

To set the aspect ratio according to the connected TV (16:9/4:3)

- Set [TV Type] to [16:9] or [4:3] according to your TV (p. 83).

When you connect with A/V connecting cable with S VIDEO

- When the S VIDEO plug (S VIDEO channel) is connected, audio signals are not output. To output audio signals, connect the white and red plugs to the audio input jack of your TV.
- This connection produces higher resolution images compared with the A/V connecting cable.

When your TV is monaural (When your TV has only one audio input jack)

- Connect the yellow plug of the A/V connecting cable to the video input jack and connect the white (left channel) or red (right channel) plug to the audio input jack of your TV or VCR.

When you connect with component A/V cable

- If you connect only component video plugs, audio signals are not output. Connect the white and red plugs to output audio signals.
- Select the [Component] setting for the component input jack you are using. Touch **MENU** (MENU) → [Setup] → [↔] (↔ Connection) → [Component] → a desired setting → **OK** to make the setting.

When you connect with HDMI cable

- Use an HDMI cable with the HDMI logo.
- Use an HDMI mini connector on one end (for the camcorder), and a plug suitable for connecting your TV on the other end.
- Copyright-protected images are not output from the HDMI OUT jack of your camcorder.
- Some TVs may not function correctly (e.g., no sound or image) with this connection.

When connecting to your TV via a VCR

- Connect your camcorder to the LINE IN input on the VCR using the A/V connecting cable. Set the input selector on the VCR to LINE (VIDEO 1, VIDEO 2, etc.).

⚡ Notes

- When you play back standard definition image quality (STD) movies on a 4:3 TV that is not compatible with the 16:9 signal, record movies with 4:3 aspect ratio. Touch **MENU** (MENU) → [Image Quality/Size] → [Wide Mode] → [4:3] → **OK** → **X** (p. 81).
- When the A/V connecting cable is used to output movies, movies are output with standard definition image quality (STD).

If your TV/VCR has a 21-pin adaptor (EUROCONNECTOR)

Use a 21-pin adaptor (sold separately) to view playback pictures.

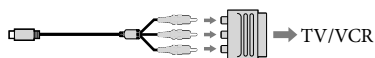

Tips

- If you turn off the TV, your camcorder is turned off simultaneously.

Tips

- If you connect your camcorder to the TV using more than one type of cable to output images, the order of priority of the TV input jacks is as follows:
HDMI → component → S VIDEO → video
- HDMI (High Definition Multimedia Interface) is an interface to send both video/audio signals. The HDMI OUT jack outputs high quality images and digital audio.

Using "BRAVIA" Sync

You can operate your camcorder with the remote commander of your TV by connecting your camcorder to a "BRAVIA" Sync compatible TV launched in 2008 or later with the HDMI cable.

You can operate the menu of your camcorder by pressing the SYNC MENU button of the remote commander of your TV. You can display the camcorder screens such as Event View, play selected movies or display selected photos by pressing up/down/left/right/enter buttons of the remote commander of your TV.

Notes

- There may be some operations you cannot do with the remote commander.
- To set your camcorder, touch **MENU** (MENU) → [Setup] → [ Connection] → [CTRL FOR HDMI] → [On] (the default setting) → **OK** → **X**.
- Also set your TV accordingly. Refer to the instruction manual of the TV for details.
- The operation of "BRAVIA" Sync differs according to each model of BRAVIA. Refer to the instruction manual of your TV for details.

Useful functions for recording movies and photos

Zooming

If the lens has a zoom ring, you can adjust the magnification by turning it to the right or left.

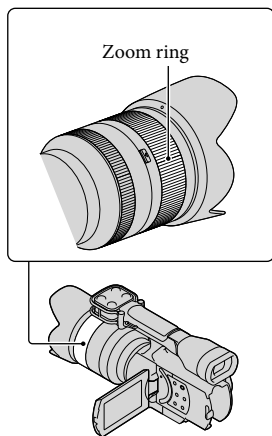

⚡ Notes

- Do not grab or apply a strong force to the lens cylinder that rolls out when zooming. The lens may be damaged.

Adjusting the focus manually

If the lens has a focusing ring, you can adjust the focus manually by turning it to the right or left.

Press FOCUS to set focusing mode to manual. ∞ appears on the LCD screen in manual focusing mode.

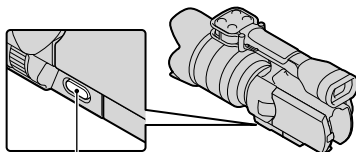

FOCUS button

- Use this function in the following cases.
 - To record a subject behind a window covered with raindrops.
 - To record horizontal stripes.
 - To record a subject with little contrast between the subject and its background.
 - When you want to focus on a subject in the background.
 - To record a stationary subject using a tripod.

To measure the exact distance to the subject

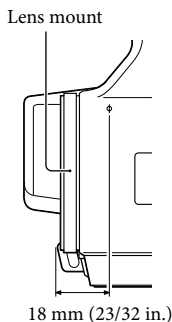

The Φ mark shows the location of the image sensor*. When you measure the exact distance between the camcorder and the subject, refer to the position of the line. The distance from the lens contact surface

to the image sensor is about 18 mm (23/32 in.).

- * The image sensor is the part of the camcorder that acts as the film.
- If the subject is closer than the minimum shooting distance** of the attached lens, the focus cannot be confirmed. Make sure you put enough distance between the subject and the camcorder.
- ** The minimum shooting distance of the lens E 18-200mm F3.5-6.3 OSS, supplied with NEX-VG20EH is 0.3 m (11 7/8 in.) (Wide end) – 0.5 m (19 3/4 in.) (Telephoto end).

Tips

- Pressing FOCUS switches [Auto] → [DMF]* → [Manual].
- * Photos only
Fine-tune manually after auto focus adjustment (Direct Manual Focus).

Using the expanded focus

Press EXPANDED FOCUS to magnify (approx. 4x) the center of the screen. This is useful for easy and accurate manual focusing.

Press EXPANDED FOCUS.

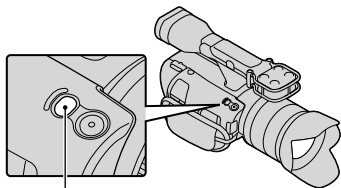

EXPANDED FOCUS button

Pressing EXPANDED FOCUS switches between expanded and normal display.

Notes

- Even though the image appears expanded on the screen, the recorded image is not expanded.
- You cannot zoom in when using [Spot Meter/Fcs], [Spot Meter] or [Spot Focus].

Selecting high definition image quality (HD) or standard image quality (STD)

You can select the desired image quality from the high definition image quality (HD) that enables you to record fine images, or the standard definition image quality (STD) that has more compatibility with various playback devices ([**HD**: HD Quality] is the default setting). Change the image quality according to the recording situation or the playback device.

1 Touch **MENU** (MENU) → [Image Quality/Size] → [**HD**]/**STD** Setting].

2 Touch [**HD**: HD Quality] to record high definition image quality (HD) images, or touch [**STD**: STD Quality] to record standard definition image quality (STD) images.

3 Touch **OK** → **OK**.
Recording image quality is changed.

Tips

- You can record, play, or edit movies in the selected image quality only. To record, play, or edit movies in another image quality, change this setting.

Selecting the recording mode

You can switch the recording mode to select the movie quality when recording high definition image quality (HD) movies ([Standard **HQ**] is the default setting).

The recording time of the memory card is changed depending on the recording mode.

1 Touch **MENU** (MENU) → [Image Quality/Size] → [ REC Mode].

2 Touch the desired recording mode.

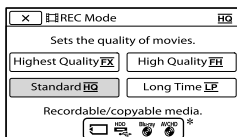

The recording modes available will depend on the selected [ Frame Rate] (p.80).

*  appears on a medium icon if a movie recorded with the selected recording mode cannot be saved on that medium.

3 Touch **OK**.

Recording modes and the media

Types of media that images can be saved on will depend on the recording mode selected.

For details on a save operation using the external devices, see page 61.

Types of media	Recording mode		
	PS*	FX	FH/ HQ/LP
On this camcorder			
Memory card	✓	✓	✓
On external devices			
External media (USB storage devices)	✓	✓	✓
Blu-ray discs	✓	✓	✓
AVCHD recording discs	—	—	✓

* [PS] can be set only when [ Frame Rate] is set to [50p].

Tips

- Movies are recorded with the 1920 × 1080/50p format when the PS mode of high definition image quality (HD) is selected, and with 1920 × 1080/50i or 1920 × 1080/25p format when the FX or FH mode is selected. When the HQ or LP mode of high definition image quality (HD) is selected, movies are recorded with 1440 × 1080/50i format.
- You can select the following high definition image quality (HD) recording mode.
 - [50p Quality **PS**] (AVC HD 28M (PS))
 - [Highest Quality **FX**] (AVC HD 24M (FX))
 - [High Quality **FH**] (AVC HD 17M (FH))
 - [Standard **HQ**] (AVC HD 9M (HQ)) (the default setting)
 - [Long Time **LP**] (AVC HD 5M (LP))
- The recording mode of the standard image quality (STD) is limited to the following value.
 - [Standard **HQ**] (STD 9M (HQ))
- “M,” such as in “24M,” means “Mbps.”

Using the Tracking focus function

If you touch the subject you want to track on the LCD screen, the camcorder tracks that subject and records a movie.

When you touch a face

A double-lined frame appears around the face and the camcorder adjusts the focus, color and exposure automatically.

When you touch a point other than a face



A double-lined frame appears at the point you touch and the camcorder adjusts the focus automatically.

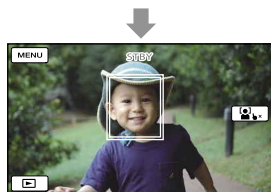

Touch the face or a point you want to track.



The double-lined frame is displayed.

To stop tracking, touch    that appears on the right of the LCD screen.

⚡ Notes

- The subject you touched may not be detected, depending on the surrounding brightness or hairstyle of the subject. In this case, touch the subject again when you record.
- If you want to track a face, set the [Face Detection] setting to other than [Off] ([Auto] is the default setting).
- When [ Frame Rate] is set to [50p], you cannot use the Tracking focus function.

💡 Tips

- If the face you touched disappears from the LCD screen, the subject selected in [Face Detection] (p. 76) has priority. If the face you touched returns to the screen, that face has priority.

Recording sound with more presence (5.1ch surround recording)

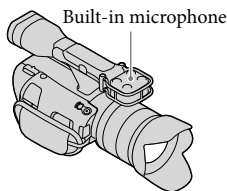

The camcorder adopts an array microphone system that has a four-capsule structure, and can record clear, low-noise sound with 5.1ch surround. Realistic sound can be enjoyed when playing a movie on devices that support 5.1ch surround sound.



⚡ Notes

- To enjoy the 5.1ch surround sound of the movies recorded with high definition image quality (HD) in 5.1ch sound, you need a device compatible with 5.1ch surround.
- When you connect your camcorder with an HDMI cable (sold separately), the sound of high definition image quality (HD) movies recorded in 5.1ch sound is automatically output in 5.1ch sound. The sound of standard definition image quality (STD) movies is converted to 2ch.

💡 Tips

- You can select the recording sound from [5.1ch Surround] () or [2ch Stereo] () ([Audio Mode], p. 78).
- You can create a disc, which contains the movies recorded on your camcorder, on a computer using the supplied software "PMB." If you play the disc on a 5.1ch surround system, you can enjoy realistic sound.

Recording in mirror mode

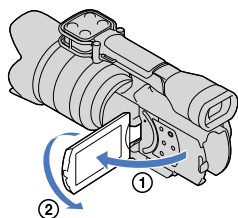

Open the LCD panel 90 degrees to the camcorder (①), then rotate it 180 degrees to the lens side (②).

Tips

- A mirror-image of the subject appears on the LCD screen, but the image will be normal when recorded.
- This picture is not displayed in the viewfinder.

Recording at a different angle

Your camcorder can record in the following angles according to the object.

- Low angle
(START/STOP button on the LCD panel)

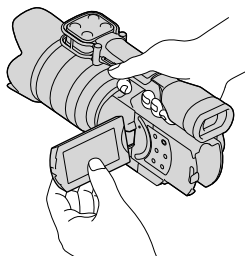

- Low angles
(START/STOP button on the grip)

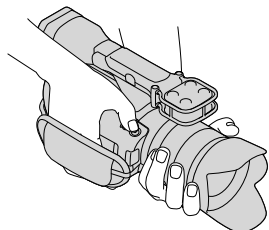

Adjusting manually

Controlling the image settings manually with the MANUAL dial

Use the MANUAL dial **B** on the camcorder for a variety of manual adjustments.

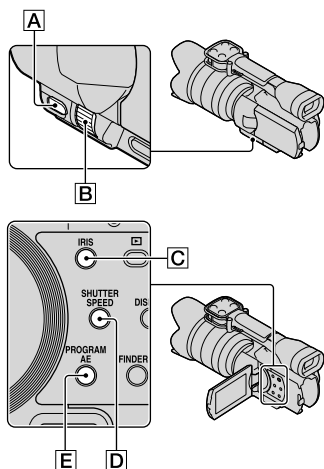

Pressing IRIS **C** switches the setting mode between automatic and manual.

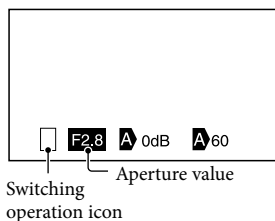

Switching operation icon

Blank

Operates manually.



Operates automatically.



Operates [Exposure] manually (p. 48).

Aperture value

When a setting value is highlighted, it can be adjusted by the MANUAL dial.

- 3 Rotate the MANUAL dial **B** to adjust the IRIS.

Adjusting the IRIS

Steps to configure IRIS priority exposure are described here.

- 1 Press PROGRAM AE **E** to set the IRIS, Gain (ISO), Shutter Speed and Exposure to [Auto].
- 2 Press IRIS **C** to set the mode to manual.

Tips

- Press IRIS again to adjust the IRIS automatically. **A** appears next to the aperture value.
- The aperture value adjustment range you can set will vary depending on the lens you use. With some lenses, the aperture value may change when you zoom from wide angle to telephoto.
- The range of focus, an important effect of the aperture, is called the depth of field. The depth of field gets shallower as the aperture is opened, and deeper as the aperture is closed. Use the aperture creatively to obtain the desired effect in your photography.
- This is handy for making the background blurred or sharp.

Adjusting the Shutter Speed

Steps to configure Shutter Speed priority exposure are described here.

- 1 Press PROGRAM AE **E** to set the IRIS, Gain (ISO), Shutter Speed and Exposure to [Auto].
- 2 Press SHUTTER SPEED **D** to set the mode to manual.
Pressing SHUTTER SPEED **D** switches the setting mode between automatic and manual.
- 3 Rotate the MANUAL dial **B** to adjust the Shutter Speed.

Tips

- Changing the Shutter Speed affects how a moving subject appears. Set a fast Shutter Speed to shoot a fast moving subject clearly without blur. Conversely, set a slow Shutter Speed to emphasize the impression of movement.
- You can set the Shutter Speed between 1/4 seconds and 1/8000 second in movie mode, and 30 second and 1/4000 second in photo mode.
- It is difficult to focus automatically at a lower Shutter Speed. Manual focusing with your camcorder attached to a tripod is recommended.
- When recording under fluorescent lamps, sodium lamps, mercury lamps, or LED lighting, the picture may have horizontal bands of noise. You may be able to improve the situation by adjusting the Shutter Speed.

To adjust the Shutter Speed automatically

Press SHUTTER SPEED **D** again. **A** appears next to the Shutter Speed value.

Adjusting Exposure

The following explanation is an example for when [Exposure] is assigned to the MANUAL **A** (default).

- 1 Press MANUAL **A** to enter the manual exposure adjustment mode.

Pressing MANUAL switches the setting mode between automatic and manual.

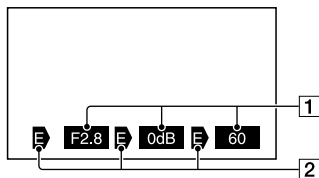

1 Setting Value

From light, IRIS, Gain (ISO), Shutter Speed

2 Status

Switching operation icon

Blank

Operates manually.



Operates automatically.



Operates [Exposure] manually (p. 48).

Aperture value

When a setting value is highlighted, it can be adjusted by the MANUAL dial.



- 2 Rotate the MANUAL dial **B** to adjust [Exposure].

The IRIS, Shutter Speed and Gain (ISO) values will change as you rotate the MANUAL dial.

To return to automatic adjustment mode

Press **MANUAL** once again. **A** appears next to the values of [IRIS], [Shutter Speed] and [Gain (ISO)], and highlighting is canceled.

Items you can assign to the MANUAL

- [Exposure]
- [Gain(ISO)]
 - Movie mode:  Gain
 - Photo mode:  ISO
- [IRIS]
- [Shutter Speed]
- [AE Shift]
- [White Balance Shift]

To assign the menu item to the MANUAL button

- 1 Press and hold **MANUAL** down for a few seconds.
The [MANUAL Button] setting screen appears.

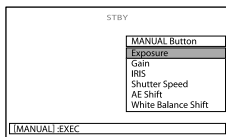



- 2 Rotate the **MANUAL** dial and select the menu item to be assigned.
- 3 Press **MANUAL**.

Notes

- Manual settings will be retained even if you change the assigned menu item of the **MANUAL** dial. However, if IRIS, Shutter Speed and Gain (ISO) are set to manual when [AE Shift] is set to [On], [AE Shift] will not be effective.

Tips

- You can also assign menu items to the **MANUAL** dial by touching **MENU** (MENU) → [Camera/Mic] →  ( Camera Settings) → [MANUAL Button].
- The **MANUAL** button works in the same way as the IRIS or SHUTTER SPEED button when [IRIS] or [Shutter Speed] is assigned. This is

useful when adjusting the IRIS or Shutter Speed with the LCD screen closed.

- The camera data (p. 83) that appears on the LCD screen will differ, depending on the recording settings of the camcorder. The settings will be displayed with the following icons.
 - **AUTO**: Automatic
 - **MANUAL**: Exposure is set manually.

Advanced manual operation

You can set the brightness of the movies you want to shoot by using IRIS, Shutter Speed and Gain (ISO).

The following explanation is an example for when IRIS is set to manual.

[Exposure] auto **A**

Shooting images are adjusted to the optimal brightness.

- 1 Press **IRIS** **C** to set the mode to manual (**A** next to the setting value disappears).

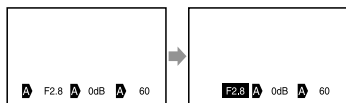

You can adjust the setting value using the **MANUAL** dial when the setting value is highlighted with no **A** shown next to it.

- 2 Rotate the **MANUAL** dial **B** to set the aperture value.

The Shutter Speed and gain (ISO) are adjusted to the ideal brightness automatically to fit the aperture value.

[Exposure] manual (E)

When using [Exposure], [Spot Meter], etc., any of the IRIS, Shutter Speed, and Gain (ISO) which are currently set to auto (A) is switched to manual (E).

The brightness is adjusted based on the value set in [Exposure], [Spot Meter], etc.

1 Set [Exposure] to manual.

- Press IRIS [C] to set the mode to manual (E next to the setting value disappears).

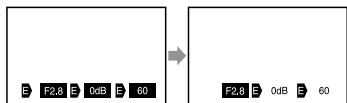

You can adjust the setting value using the MANUAL dial when the setting value is highlighted with no E shown next to it.

- Rotate the MANUAL dial [B] to set the aperture value.

The values of Shutter Speed and Gain (ISO) change, according to the value set in [Exposure], [Spot Meter], etc.

Full manual

You can use full manual mode when you set all of IRIS, Shutter Speed and Gain (ISO) to manual.

The relationship between the three modes

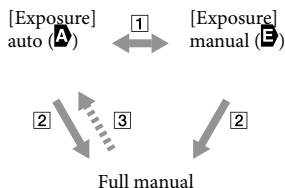

- [Exposure], [Spot Meter] set to manual/auto.
- When all of IRIS, Shutter Speed, Gain (ISO) is set to manual.
- At least, one of [2] is set to [Auto].

Tips

- IRIS, Shutter Speed and Gain (ISO) will all be set to automatic adjustment when PROGRAM AE is pressed.
- Among IRIS, Shutter Speed and Gain (ISO), only the item(s) which is set to E returns to A when you touch [Auto] on the screen for [Exposure], [Spot Meter], etc.

Making good use of your camcorder

Deleting movies and photos

You can free media space by deleting movies and photos from memory card.

Notes



- You cannot restore images once they are deleted. Save important movies and photos in advance.
- Do not remove the battery pack or the AC Adaptor from your camcorder while deleting the images. It may damage the memory card.
- Do not eject the memory card while deleting images from the memory card.
- You cannot delete protected movies and photos. Undo the protection of the movies and photos to delete them, before you try to delete them (p. 51).

Tips

- You can delete the image using  on the playback screen.
- To delete all images recorded in the memory card, and recover all the recordable space of the media, format the media (p. 82).
- Reduced-size images which enable you to view many images at the same time on an index screen are called “thumbnails.”

1 Press  (View Images) button (p. 34).

2 Touch **MENU** (MENU) → [Edit/Copy] → [Delete].

3 To select and delete movies, touch [Multiple Images] → [**H**HD: MOVIE]/[ PHOTO]/ [ MOVIE/PHOTO].

- When [**H**HD/ **H**STD Setting] is set to [**H**STD: STD Quality], **H**STD appears instead of **H**HD.

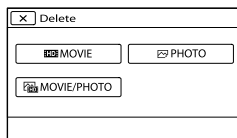

4 Touch and display the  mark on the movies or photos to be deleted.

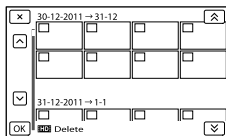



- Touch and hold the desired thumbnail so that you can confirm the image. Touch  to return to the previous screen.

5 Touch **OK** → **OK** → **OK**.

To delete all movies/photos in an event at one time

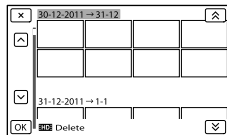
1 In step 2, touch [All In Event].



2 Touch  /  to select the desired event, then touch **OK**.

- Touch and hold the desired thumbnail so that you can confirm the image. Touch  to return to the previous screen.

3 Touch **OK** → **OK**.

Protecting recorded movies and photos (Protect)

Protect movies and photos to avoid deleting them by mistake.

☞ will be displayed on the protected images.

1 Press (View Images) button (p. 34).

2 Touch **MENU** (MENU) → [Edit/Copy] → [Protect].

3 To select and protect movies, touch [Multiple Images] → [**FHD**: MOVIE]/[PHOTO]/ [MOVIE/PHOTO].

- When [**FHD**: **STD**] Setting is set to [**STD**: STD Quality], **STD** appears instead of **FHD**.

4 Touch the movies and photos to be protected.

✓ is displayed on the selected images.

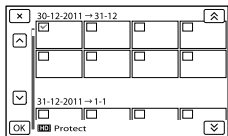

- Touch and hold the desired thumbnail so that you can confirm the image. Touch to return to the previous screen.

5 Touch **OK** → **OK** → **OK**.

To undo the protection of movies and photos

Touch the movie or photo marked with ✓ in step 4.

✓ disappears.

To protect all movies/photos in an event at one time

① In step 3, touch [Set All In Event].

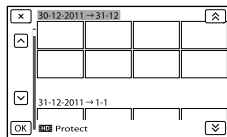

② Touch / to select the desired event, then touch **OK**.

- Touch and hold the desired thumbnail so that you can confirm the image. Touch to return to the previous screen.

③ Touch **OK** → **OK**.

To undo the protection of an event

In step 3 above, touch [Remove All In Event], select the desired movies/photos, then touch **OK** → **OK** → **OK**.



Dividing a movie

You can divide a movie to delete unnecessary parts.

1 Touch → [Divide] on the movie playback screen.

2 Touch , then touch at the point where you want to divide the movie into scenes.

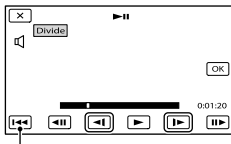

The movie pauses.

- 3 Touch  /  to adjust the dividing point with more precision.





Returns to the beginning of the selected movie

- 4 Touch  → .

- 2 Touch , then touch  at the point where you want to capture a photo.

The movie pauses.

- 3 Touch  /  to adjust the capturing point with more precision.

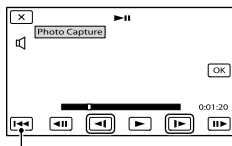

Returns to the beginning of the selected movie

- 4 Touch .

When capturing is finished, the screen returns to pause.

⚡ Notes

- You cannot restore movies once they are divided.
- You cannot divide protected movie. Undo the protection of the movie to divide it, before you try to divide it (p. 51).
- Do not remove the battery pack or the AC Adaptor from your camcorder while dividing the movie. It may damage the memory card.
- Do not eject the memory card while dividing movies on the memory card.
- A slight difference may occur from the point where you touch  and the actual dividing point, as your camcorder selects the dividing point based on about half-second increments.
- Only simple editing is available on the camcorder. Use the supplied software “PMB” for more advanced editing.

Capturing a photo from a movie

You can capture images from movies recorded with your camcorder.

- 1 Touch  → [Photo Capture] that appears on the playback screen of a movie.





The [Photo Capture] screen appears.

⚡ Notes

- The image size is fixed based on the image quality of the movie. If the movie was recorded with one of the following image quality levels, the image size will be set as shown below.
 - High definition image quality (HD): 2.1 M (16:9)
 - Wide aspect ratio (16:9) with standard definition image quality (STD): 0.2 M (16:9)
 - 4:3 aspect ratio with standard definition image quality: 0.3 M (4:3)
- The memory card where you want to save photos should have enough free space.
- The recording date and time of captured photos is the same as the recording date and time of the movies.
- If the movie you are capturing from has no data code, the recording date and time of the photo will be the date and time you captured from the movie.

Selecting the method for creating a disc (computer)

Several methods for creating a high definition image quality (HD) disc or a standard definition image quality (STD) disc from high definition image quality (HD) movies or photos recorded on your camcorder are described here. Select the method that suits your disc player.

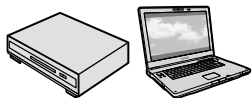
Disc type	Choosing a method	Player
 <p>To save images on a Blu-ray disc with high definition image quality (HD)</p>	<ol style="list-style-type: none"> ① Importing movies and photos to a computer (p. 56) ↓ ② Creating a Blu-ray disc* with high definition image quality (HD) (p. 58) 	<p>Blu-ray disc playback devices (a Sony Blu-ray disc player, PlayStation[®]3, etc.)</p> 
 <p>To save images on a AVCHD recording disc with high definition image quality (HD)</p>	<p>Creating a disc with one touch (Disc Burn) (p. 55)</p> <hr/> <ol style="list-style-type: none"> ① Importing movies and photos to a computer (p. 56) ↓ ② Creating a AVCHD recording disc with high definition image quality (HD) (p. 57) 	<p>AVCHD format playback devices (a Sony Blu-ray disc player, PlayStation[®]3, etc.)</p> 
 <p>To copy images on a disc in standard definition image quality (STD) to distribute</p>	<ol style="list-style-type: none"> ① Importing movies and photos to a computer (p. 56) ↓ ② Creating a standard definition image quality (STD) disc (p. 57) 	<p>Ordinary DVD playback devices (a DVD player, a computer that can play DVDs, etc.)</p> 

* To create a Blu-ray disc, the BD Add-on Software for "PMB" must be installed (p. 58).

Discs you can use with “PMB”

You can use 12 cm discs of following type with “PMB.” For Blu-ray disc, see page 58.

Disc type	Features
DVD-R/DVD+R/DVD+R DL	Unrewritable
DVD-RW/DVD+RW	Rewritable

⚡ Notes

- Always maintain your PlayStation®3 to use the latest version of the PlayStation®3 system software.
- The PlayStation®3 may not be available in some countries/regions.

Creating a disc with one touch

(Disc Burn)

Movies and photos recorded on your camcorder that have not yet been saved with Disc Burn function can be saved on a disc automatically. Movies and photos are saved on a disc with their recorded image quality.

⚡ Notes

- High definition image quality (HD) movies (the default setting) will make an AVCHD recording disc.
- You cannot create AVCHD recording discs from movies recorded with [HD FX] or [50p Quality PS] mode of [REC Mode].
- Creating a Blu-ray disc is not available with Disc Burn.
- To create a standard definition image quality (STD) disc from high definition image quality (HD) movies, import movies to a computer first (p. 56), and then create a standard definition image quality (STD) disc (p. 42).
- Install "PMB" beforehand, however, do not start "PMB."
- Connect your camcorder to the wall outlet (wall socket) using the supplied AC Adaptor for this operation (p. 16).

1 Turn on your computer, and place an unused disc on the DVD drive.

- See page 54 for the type of discs you can use.
- If any other software than "PMB" starts automatically, shut it down.

2 Turn on your camcorder, then connect the camcorder to the computer using the USB cable (supplied).

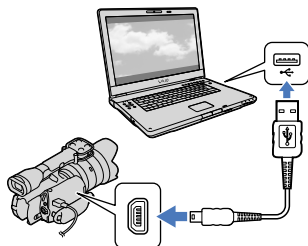

3 Touch [Disc Burn] on the camcorder screen.

4 Follow the instructions on the computer screen.

⚡ Notes

- Movies and photos are not saved on the computer when you perform Disc Burn.
- Photos recorded in RAW format are not saved on a disc.

Importing movies and photos to a computer

Movies and photos recorded on your camcorder can be imported to a computer. Turn on the computer beforehand.

⚡ Notes

- Connect your camcorder to the wall outlet (wall socket) using the supplied AC Adaptor for this operation (p. 16).

- 1 Turn on your camcorder, then connect the camcorder to the computer using the USB cable (supplied).

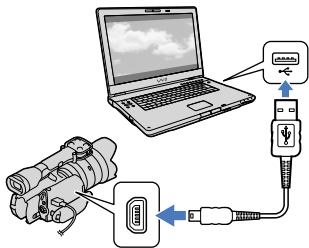

The [USB Select] screen appears on the camcorder screen.

- 2 Touch [USB Connect] on the camcorder screen.

- If the [USB Select] screen does not appear, touch **MENU** (MENU) → [Setup] → [↔ (↔ Connection)] → [USB Connect].

The window for import appears on the computer screen.

If you want to change the location where imported media files will be saved, click [PMB] → [Tools] → [Settings...] → [Import media files to] → [Browse...], then select the desired location.

- 3 Click [Import].

- Refer to “PMB Help” for details.

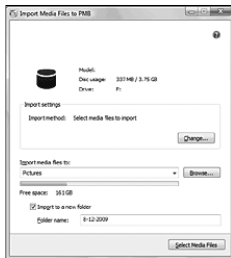

Movies and photos are imported to your computer.

When the operation is completed, the “PMB” screen appears.

💡 Tips

- You can move the high definition image quality (HD) movies from a computer back to the camcorder. Connect the camcorder to the computer using the USB cable (supplied), select the destination device for the movie to be exported (in this case, your camcorder) on the computer screen, select the movie to be exported, then click [Export] (under the [Manipulate] category) → select the drive to export the files to → click [Export] → click [OK] on the export complete screen.

Saving images on a disc

You can select movies that have been imported to a computer and save them on a disc.

1 Turn on your computer, and place an unused disc on the DVD drive.

- See page 53 for the type of discs you can use.
- If any other software than “PMB” starts automatically, shut it down.

2 Start “PMB.”

3 Click [Calendar] or [Index] to select the date or folder, and select the movie you want to save on the disc.

- High definition image quality (HD) movies are marked with **HD**.
- To select plural movies, hold the Ctrl key down and click thumbnails.

4 Click  (Create Disc) to select the type of disc you want to use.

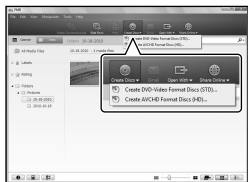

The movie selection window appears. [Create AVCHD Format Discs (HD)]:

You can save movies with high definition image quality (HD) on a DVD disc.

[Create DVD-Video Format Discs (STD)]:

You can save movies with standard definition image quality (STD) on a DVD disc. You can select high definition image quality (HD) movies as sources. However, saving such movies will take longer than the actual length of the movies, because the image quality must be converted from high definition (HD) to standard definition (STD) when saving the movie on the disc.

- To add movies to the previously selected ones, select the movies in the main window and drag and drop onto the window for selecting movies.

5 Follow the instructions on the screen to create a disc.

- It may take a long time to create a disc.

Playing an AVCHD recording disc on a computer

You can play back AVCHD recording discs using “Player for AVCHD” that is installed together with “PMB.”

To start “Player for AVCHD”

Click [Start] → [All Programs] → [PMB] → [PMB Launcher] → [View] → [Player for AVCHD].

See the “Player for AVCHD” help on the operation.

- Movies may not be played smoothly depending on the computer environment.

Creating a Blu-ray disc

You can create a Blu-ray disc with a high definition image quality (HD) movie previously imported to a computer (p. 56). To create a Blu-ray disc, the BD Add-on Software for “PMB” must be installed. Click [BD Add-on Software] on the installation screen of “PMB,” and install this plug-in according to the on-screen instructions.

- Connect your computer to the internet when you install [BD Add-on Software].



Place an unused Blu-ray disc in the disc drive, and click  → [Create Blu-ray Disc (HD)] in step 4 of “Saving images on a disc” (p. 57). Other procedures are the same as that for creating an AVCHD disc.

- Your computer must support the creation of Blu-ray discs.
- BD-R (unrewritable) and BD-RE (rewritable) media are available for creating Blu-ray discs. You cannot add contents to either type of disc after creating the disc.
- You need a device compliant with AVCHD format Ver.2.0 compatible to play a Blu-ray disc created from movies recorded in [50p Quality **PS**].

Copying a disc



You can copy a recorded disc to another disc using “Video Disc Copier.”

Click [Start] → [All Programs] → [PMB] → [PMB Launcher] → [Disc Creation] → [Video Disc Copier] to start the software. See “Video Disc Copier” help on the operation.

- You cannot copy high definition image quality (HD) movies by converting them to standard definition image quality (STD).
- You cannot copy to a Blu-ray disc.

Selecting a method for saving images with an external device

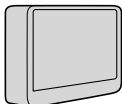
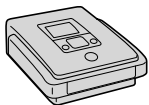
You can save high definition image quality (HD) movies using an external device. Select the method to be used according to the device.

External devices	Connecting cable	Page
 <p>External media device Saving images on an external media device with high definition image quality (HD).</p>	USB Adaptor Cable VMC-UAM1 (sold separately)	61
 <p>DVD writer (Except DVDExpress) Saving images on a DVD disc with high definition image quality (HD) or with standard definition image quality (STD).</p>	USB cable (supplied)	64
 <p>Hard disk recorder, etc. Saving images on a DVD disc with standard definition image quality (STD).</p>	A/V connecting cable (supplied)	65

Movies that are recorded with standard definition image quality (STD)

Use the A/V connecting cable to connect the camcorder to an external device in which images are saved.

⚡ Notes

- The AVCHD recording disc can be played back only on AVCHD format compatible devices.
- Discs with high definition image quality (HD) images recorded should not be used in DVD players/recorders. Because DVD players/recorders are not compatible with the AVCHD format, DVD players/recorders may fail to eject the disc.

The types of media on which images are saved

Refer to “Recording modes and the media” on page 43.

DVD disc with high definition image quality (HD)

AVCHD format playback devices, such as a Sony Blu-ray disc player or a PlayStation®3.

DVD disc with standard definition image quality (STD)

Ordinary DVD playback devices, such as a DVD player.

Notes

- Always maintain your PlayStation®3 to use the latest version of the PlayStation®3 system software.
- The PlayStation®3 may not be available in some countries/regions.

Saving images on an external media device

You can save movies and photos on an external media device (USB storage devices), such as an external hard disk drive. You can also play back images on the camcorder or another playback device.

⚡ Notes

- For this operation, you need the USB Adaptor Cable VMC-UAM1 (sold separately).
- The USB Adaptor Cable VMC-UAM1 may not be available in some countries/regions.
- Connect your camcorder to the wall outlet (wall socket) using the supplied AC Adaptor (p. 16).
- Refer to the instruction manual supplied with the external media device.

💡 Tips

- You can import images saved on the external media device to your computer by using the supplied software “PMB.”

Functions available after saving images on an external media device

- playback of images through the camcorder (p. 63)
- importing images to “PMB”

Devices that cannot be used as an external media device

- You cannot use the following devices as an external media device.
 - media devices with a capacity exceeding 2 TB
 - ordinary disc drive such as CD or DVD drive
 - media devices connected via a USB hub
 - media devices with built-in USB hub
 - card reader

⚡ Notes

- You may not be able to use external media devices with a code function.
- The FAT file system is available for your camcorder. If the storage medium of the external device was formatted for the NTFS file system, etc., format the external media device using the camcorder before use. The format screen appears when an external media device is connected to your camcorder. Make sure that

important data has not previously been saved on the external media device before you format it using the camcorder.

- Operation is not assured with every device satisfying requirements for operating.
- For details on available external media devices, go to the Sony support website in your country/region.

1 Connect the AC Adaptor and the power cord (mains lead) to the DC IN jack of your camcorder and the wall outlet (wall socket).

2 If the external medium device has the AC power cable, connect it to the wall outlet (wall socket).

3 Connect the USB Adaptor Cable to the external media device.

4 Connect the USB Adaptor Cable to the Ψ (USB) jack of your camcorder.

Make sure not to disconnect the USB cable while [Preparing image database file. Please wait.] is displayed on the LCD screen. If [Repair Img. DB F.] is displayed on the camcorder screen, touch **OK**.

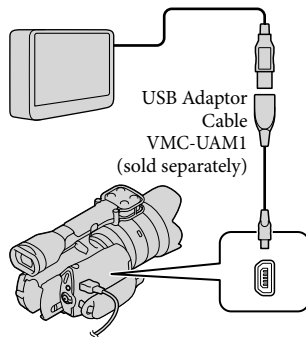

5 Connect the external media device to the camcorder and touch [Copy.] on the camcorder screen.

Movies and photos that are stored in the memory card and that have not yet been saved on external media device can be saved on the connected media device at this time.

- This operation is available only when there are newly recorded images.

6 After operation is completed, touch **OK** on the camcorder screen.

To disconnect the external media device

- ① Touch **⏏** while the camcorder is in the playback standby mode ([Event View] or Event Index is displayed) of the external media device.
- ② Disconnect the USB Adaptor Cable.

⚡ Notes

- The number of scenes you can save on the external media device are as follows. However, even if the external media device has free space, you cannot save scenes exceeding the following number.
 - High definition image quality (HD) movies: Max. 3,999
 - Standard definition image quality (STD) movies: Max. 9,999
 - Photos: Max. 40,000
 The number of scenes may be smaller depending on the type of images recorded.

When connecting an external media device

The images saved in the external media device are displayed on the LCD screen. When an external media device is connected, the USB icon will appear on the Event View screen, etc.

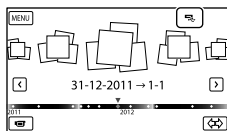

You can make menu settings of the external media device such as deleting images. Touch **MENU** (MENU) → [Edit/Copy] on Event View.

Saving desired movies and photos

You can save desired images in the camcorder to the external media device.

1 Connect the camcorder to the external media device and touch [Play without copying].

Event View of the external medium is displayed.

2 Touch **MENU** (MENU) → [Edit/Copy] → [Copy].

3 Follow the instructions that appear on the screen to select image selection methods and type of the image.

You cannot copy images from an external media device to the internal recording medium on the camcorder.

-
- 4 When you selected [Multiple Images], touch the image to be saved.

✓ appears.



- Press and hold the image down on the LCD screen to confirm the image. Touch **X** to return to the previous screen.
- If you select [All In Event], select the event to copy with **▲** / **▼**. You cannot select multiple events.

-
- 5 Touch **OK** → **OK** → **OK** on the camcorder screen.
-

Playing back images in the external media device on the camcorder

- 1 Connect the camcorder to the external media device and touch [Play without copying].

Event View of the external media device is displayed.

- 2 Select the image you want to view and play back the image (p. 34).

- You can also view images on a TV connected to your camcorder (p. 38).
 - You can play back the high definition image quality (HD) movies on your computer using [Player for AVCHD]. Start [Player for AVCHD], and select the drive where the external media device is connected with [Settings].
-

To perform [Direct Copy] manually You can perform [Direct Copy] manually while the camcorder is connected to an external media device.

- ① Touch **MENU** (MENU) → [Edit/Copy] → [Direct Copy] on the [Event View] screen of the external media device.
- ② Touch [Copy images that have not been copied.].
- ③ Touch **OK** → **OK**.

Notes

- If your camcorder does not recognize the external media device, try the following operations.
 - Reconnect the USB Adaptor Cable to your camcorder.
 - If the external media device has the AC power cord (mains lead), connect it to the wall outlet (wall socket).

Creating a high definition image quality (HD) disc with such as a Sony DVD writer, etc.

Use the USB cable to connect your camcorder to a disc creation device, which is compatible with high definition image quality (HD) movies, such as a Sony DVD writer. Refer also to the instruction manuals supplied with the device to be connected.

⚡ Notes

- Connect your camcorder to the wall outlet (wall socket) using the supplied AC Adaptor for this operation (p. 16).
- Sony DVD writer may not be available in some countries/regions.
- Your camcorder is not compatible with DVDExpress.

1 Connect the AC Adaptor and the power cord (mains lead) to the DC IN jack of your camcorder and the wall outlet (wall socket) (p. 16).

2 Turn on your camcorder, and connect a DVD writer, etc. to your camcorder with the USB cable (supplied).

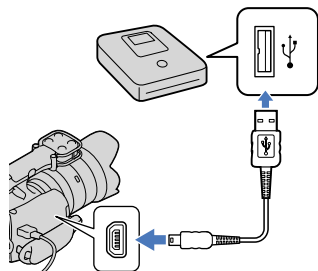

The [USB Select] screen appears on the camcorder screen.

- If the [USB Select] screen does not appear, touch **MENU** (MENU) → [Setup] → [↔ (↔ Connection)] → [USB Connect].

3 Touch [USB Connect] on the camcorder screen.

- The displayed recording media differ depending on the model.

4 Record movies on the connected device.

- For details, refer to the instruction manuals supplied with the device to be connected.

5 After the operation is completed, touch **X** → **OK** on the camcorder screen.

6 Disconnect the USB cable.

Creating a standard definition image quality (STD) disc with a recorder, etc.

You can copy images played back on your camcorder on a disc or video cassette, by connecting your camcorder to a disc recorder, a Sony DVD writer, etc., other than DVDDirect Express, with the A/V connecting cable. Connect the device in either way of **1** or **2**. Refer also to the instruction manuals supplied with the devices to be connected.

⚡ Notes

- Connect your camcorder to the wall outlet (wall socket) using the supplied AC Adaptor for this operation (p. 16).
- Sony DVD writer may not be available in some countries/regions.
- High definition image quality (HD) movies will be copied with standard definition image quality (STD).

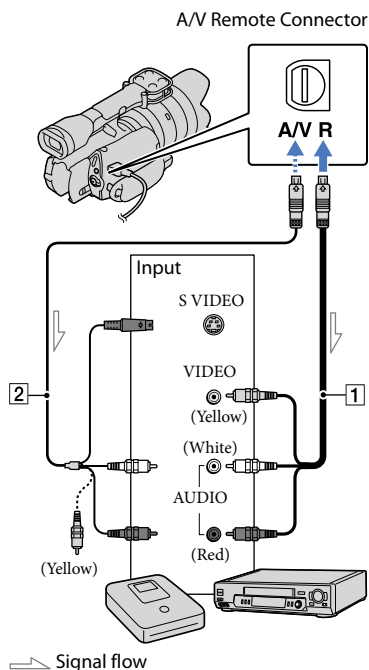

➤ Signal flow

1 A/V connecting cable (supplied)

2 A/V connecting cable with S VIDEO (sold separately)

By using this cable, higher quality images can be produced than with an A/V connecting cable. Connect the white and red plug (left/right audio) and the S VIDEO plug (S VIDEO channel) of the A/V connecting cable with an S VIDEO cable. If you connect the S VIDEO plug only, you will hear no sound. The yellow plug (video) connection is not necessary.

1 Insert the recording media in the recording device.

- If your recording device has an input selector, set it to the input mode.

2 Connect your camcorder to the recording device (a disc recorder, etc.) with the A/V connecting cable **1** (supplied) or an A/V connecting cable with S VIDEO **2** (sold separately).



- Connect your camcorder to the input jacks of the recording device.

3 Start playback on your camcorder, and record it on the recording device.

- Refer to the instruction manuals supplied with your recording device for details.







4 When dubbing is finished, stop the recording device, and then your camcorder.

Notes

- Since copying is performed via analog data transfer, the image quality may deteriorate.
- You cannot copy images to recorders connected with an HDMI cable.
- To copy date/time information and camera data, touch **MENU** (MENU) → [Setup] → [] (Playback Settings) → [Data Code] → a desired setting → **OK**.
- When the screen size of display devices (TV, etc.) is 4:3, touch **MENU** (MENU) → [Setup] → [] (Connection) → [TV Type] → [4:3] → **OK**.
- When you connect a monaural device, connect the yellow plug of the A/V connecting cable to the video input jack, and the white (left channel) or the red (right channel) plug to the audio input jack on the device.

Using menus

You can enjoy using your camcorder more by making good use of menu operations. The camcorder has various menu items under each of 6 menu categories.

-  **Shooting Mode (Items for selecting a shooting mode)** → p. 72
-  **Camera/Mic (Items for customized shooting)** → p. 72
-  **Image Quality/Size (Items for setting up image quality or size)** → p. 80
-  **Playback Function (Items for playback)** → p. 34
-  **Edit/Copy (Items for editing)** → p. 82
-  **Setup (Other setup items)** → p. 82

Operating menus

Follow the procedures explained below to set the menu items.

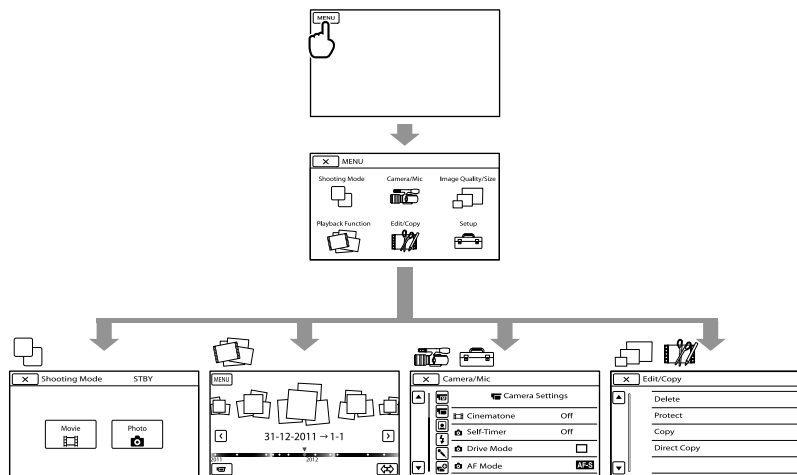

The [Camera/Mic] and [Setup] menus have sub-categories. Touch the sub-category icon, and the screen changes to other sub-category menus.

Grayed out menu items or settings are not available.

Notes





- You may not be able to set some menu items, depending on the recording or playback conditions.
- Touch  to finish setting the menu or to return to the previous menu screen.

Menu lists

Shooting Mode

Movie	Records movies.	72
Photo	Shoots photos.	72

Camera/Mic



 ( Manual Settings)		
White Balance	Adjusts the White Balance.	72
Spot Meter/Fcs	Adjusts the brightness and focus for the selected subject simultaneously.	73
Spot Meter	Adjusts and fixes the exposure to the subject, so that it is recorded at a suitable brightness.	73
Spot Focus	Focuses on a subject you touch on the screen.	73
Exposure	Fixes the brightness of a picture manually.	73
 Gain	Sets the gain.	74
 ISO	Sets the luminous sensitivity for recording still images.	74
AE Shift	Adjusts the brightness of automatic exposure control.	74
White Balance Shift	Adjusts the white balance with more precision.	75
 ( Camera Settings)		
 Cinematone	Adjusts the color of the movie automatically to resemble the atmosphere of film camera images.	75
 Self-Timer	Sets the self-timer when your camcorder is in photo recording mode.	75
 Drive Mode	Sets continuous or bracket shooting, etc.	75
 AF Mode	Selects the focus method.	75
 SteadyShot	Sets the SteadyShot function when recording movies.	76
 SteadyShot	Sets the SteadyShot function when shooting photos.	76
Auto Back Light	Adjusts the exposure for backlit subjects automatically.	76
MANUAL Button	Allows you to select a menu item to assign to the MANUAL button.	46
 ( Face)		
Face Detection	Detects a face.	76

 ( Flash)

Flash	Sets how the flash is activated when shooting photos.	77
Flash Level	Sets the brightness of flash.	77
Red Eye Reduction	Prevents redeye when shooting with flash.	77







 ( Microphone)

Wind Noise Reduct.	Sets wind noise reduction of the internal microphone.	77
Audio Mode	Changes the recording sound format.	78
Audio Rec Level	Adjusts the audio level when recording.	78

 ( Shooting Assist)

Guide Frame	Displays the frame to check that the subject is horizontal or vertical.	78
Zebra	Displays a zebra pattern as a guide for adjusting brightness.	78
Peaking	Displays an image on the screen with its outlines enhanced you to adjust the focus.	78
Histogram	Displays the histogram.	79
Camera Data Display	Displays the value of iris, gain (ISO) and shutter speed.	79
Audio Level Display	Displays the audio level meter on the screen.	79
AF Micro Adjustment	Adjusts the focus for the attached lens.	80

 Image Quality/Size

 REC Mode	Sets the mode to record movies.	43
 Frame Rate	Sets the frame rate to record movies.	80
 HDMI / STD Setting	Sets image quality for recording, playback, or editing movies.	42
 Wide Mode	Selects the aspect ratio when recording with standard definition image quality (STD).	81
 Image Size	Sets the photo size.	81
 RAW/JPEG	Selects the compression format of still images.	81

 Playback Function

Enables you to view recorded movies/photos.	34
---	----

 Edit/Copy

Delete	Deletes movies or photos.	50
Protect	Protects movies or photos to avoid deleting.	51
Copy	Selects and copies movies or photos to external media.	62
Direct Copy	Copies any images that have not been stored to external media.	63

 Media Settings

Media Info	Displays information on the recording media, such as free space.	82
Format	Deletes all data on the recording media.	82
Repair Img. DB F.	Repairs the image database file on the internal recording media or a memory card.	92, 95
File Number	Sets how to assign the file number.	83

 Playback Settings

Data Code	Displays the detailed recording data during playback.	83
Volume	Adjusts the volume during playback, and the volume for the headphones during recording.	83

 Connection

TV Type	Converts the output signal depending on the aspect ratio of the connected TV.	83
Component Output	Sets this when connecting your camcorder to a TV with a component input jack.	84
HDMI Resolution	Selects the type of signal output to a TV via the HDMI jack.	84
CTRL FOR HDMI	When connecting your camcorder to a "BRAVIA" Sync compatible TV with an HDMI cable (sold separately), you can play back movies on your camcorder by aiming the TV's Remote Commander at the TV.	84
USB Connect	Uses a USB connection with the USB cable.	85
USB Connect Setting	Sets the USB transfer mode for connecting the camcorder to a computer or other USB device.	85
Disc Burn	Allows you to save images onto discs by a single press of a button.	55

 General Settings

Beep	Sets whether the camcorder sounds operation beeps or not.	85
LCD Brightness	Adjusts the brightness of the LCD screen.	85
VF Brightness	Adjusts the brightness of the viewfinder.	85
Display Setting	Sets the duration that icons or indicators are displayed on the LCD screen.	86
REC Lamp	Turns off the recording lamp on the front of your camcorder.	86
Shooting w/o Lens	Sets whether or not to record images when there is no lens.	86
Remote Ctrl	Enables/disables use of the supplied Wireless Remote Commander.	86
A. Shut Off	Sets your camcorder to turn off automatically.	86
Language Setting	Selects the language to be used on the LCD screen.	86

Calibration	Adjusts the touch panel.	104
Battery Info	Displays the battery information.	87
Version	Displays the version of your camcorder and lens.	87
⌚ (Clock Settings)		
Date & Time Setting	Sets the [Date & Time], [Summer Time], or [Date & Time Format].	87
Date & Time Format	Sets the [Date & Time Format].	87
Summer Time	Sets the [Summer Time].	87
Date & Time	Sets the [Date & Time].	87
Area Setting	Adjusts for a time difference without stopping the clock.	87

Shooting Mode

(Items for selecting a shooting mode)

See “Using menus” (p. 67) on the operation. The default settings are marked with ►.

Movie

You can record movies.

Photo

You can shoot photos.



Camera/Mic

(Items for customized shooting)

See “Using menus” (p. 67) on the operation. The default settings are marked with ►.

White Balance



You can adjust the color balance to the recording environment.



► Auto

The white balance is adjusted automatically.

Outdoor (☀)

The white balance is appropriately adjusted for the following recording conditions:

- Outdoors
- Night views, neon signs and fireworks
- Sunrise or sunset
- Under daylight fluorescent lamps

Indoor (💡)

The white balance is appropriately adjusted for the following recording conditions:

- Indoors
- At party scenes or studios where the lighting conditions change quickly
- Under video lamps in a studio, or under sodium lamps or incandescent-like color lamps

One Push (📷)

The white balance will be adjusted according to the ambient light.

- ① Touch [📷].
- ② Frame a white object such as a piece of paper, to fill the screen under the same lighting conditions as you will shoot the subject.
- ③ Touch [📷^{SET}].

⚡ Notes

- Set [White Balance] to [Auto] or adjust the color in [One Push] under white or cool white fluorescent lamps.
- When you select [One Push], keep framing white objects.
- While the camcorder is recording a movie,  is grayed out and [One Push] cannot be set.

💡 Tips

- If you have changed the battery pack while [Auto] was selected, or taken your camcorder outdoors after inside use (or vice versa), aim your camcorder at a nearby white object for about 10 seconds for better color balance adjustment.
- When the white balance has been set with [One Push], if the lighting conditions changed by bringing your camcorder outdoors from inside the house, or vice versa, you need to redo the [One Push] procedure to readjust the white balance.

Spot Meter/Fcs (Spot meter/focus)

You can adjust the brightness and focus for the selected subject simultaneously. This function enables you to use [Spot Meter] (p. 73) and [Spot Focus] (p. 73) at the same time.

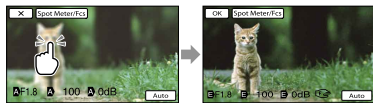

Touch the subject of which you want to adjust the brightness and focus. To adjust the brightness and focus automatically, touch [Auto].

⚡ Notes

- [Exposure] and [Focus] are automatically set to [Manual].
- [Auto] is set when the focus is set to [DMF] in photo shooting mode.

Spot Meter (Flexible spot meter)

You can adjust and fix the exposure to the subject, so that it is recorded in suitable brightness even when there is strong contrast between the subject and the background, such as subjects in the spotlight on stage.

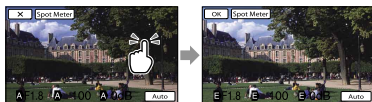

Touch the subject of which you want to adjust the exposure. To return the setting to automatic exposure, touch [Auto].

⚡ Notes

- [Exposure] is automatically set to [Manual].

Spot Focus

You can select and adjust the focal point to aim it at a subject not located at the center of the screen.

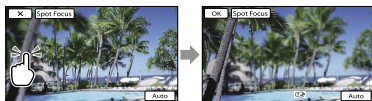

Touch the subject of which you want to adjust the focus. To adjust the focus automatically, touch [Auto].

⚡ Notes

- [Focus] is automatically set to [Manual].

Exposure

You can fix the brightness of a picture manually. Adjust the brightness when the subject is too bright or too dark.

► Auto

Adjusts automatically depending on the image being recorded.

Manual

Adjusts manually.



Touch **-** / **+** to adjust the brightness. To adjust the exposure automatically, touch [Auto].

💡 Tips

- You can also adjust manually by using the MANUAL dial (p. 46).

📺 Gain

You can adjust the gain manually when you do not want to use the AGC (automatic gain control).

► Auto

Adjusts automatically.

Manual

Adjusts gain value (0 dB~30 dB) manually.

💡 Tips

- Noise increases at higher gain values.

📷 ISO

Sets the luminous sensitivity for recording still images.

► Auto

Your camcorder sets the appropriate ISO sensitivity according to the ambient light.

Manual

Fix to the ISO (100/200/400/800/1600/3200/6400/12800/25600) adjusted manually.

🔊 Notes

- The larger the number, the higher the noise level.

💡 Tips

- You can set a faster shutter speed, and reduce image blur in dark locations or of moving subjects by increasing ISO sensitivity (select a larger number).
- Gain/ISO Sensitivity (Recommended Exposure Index) is the sensitivity to light of recording media that incorporates an image sensor that receives light. Even when the exposure is the same, images differ depending on the Gain/ISO setting.

– High Gain/ISO sensitivity

With high Gain/ISO sensitivity, images will be captured with an appropriate brightness even under insufficient exposure. However, increasing Gain/ISO sensitivity will cause images to become noisy.



– Low Gain/ISO sensitivity

You can record smooth images. However, the shutter speed may slow down to compensate for low Gain/ISO sensitivity. You should take camera shake or movement of subjects into account, too.



AE Shift

You can adjust the exposure manually.

► Off

Optimizes exposure automatically.

On (EV and adjusted number)

Allows for further manual adjustment, after optimum exposure has been determined by your camcorder.

Tips

- You can adjust the automatic exposure level to brighter or darker when [Exposure] is set to [Auto].
- Touch **+** if the subject is white or the backlight is bright, or touch **-** if the subject is black or the light is dim.
- You can also adjust manually by using the MANUAL dial (p. 46).

White Balance Shift

You can adjust the white balance manually.

- ▶ **Off**
Adjusts the white balance automatically.
- On (WS and adjusted number)**
Adjusts the white balance manually.

Tips

- When the white balance is set to a lower value, images appear bluish, and when it is set to higher value, images appear reddish.
- You can also adjust manually by using the MANUAL dial (p. 46).

Cinematone

The camcorder automatically adjusts the color of the movie to resemble the atmosphere of film camera images when recording a movie.

- ▶ **Off**
Does not use the Cinematone function.
- On**
Uses the Cinematone function.

Notes

- When you switch the [ Cinematone] function on or off, the image will be paused temporarily.

Self-Timer

Press PHOTO to start the count down. A photo is recorded after about 10 seconds.

- ▶ **Off**
Cancels the self-timer.
- On (☺)**
Starts the self-timer recording. To cancel the recording, touch [Reset].

Tips

- You can also operate by pressing PHOTO on the Wireless Remote Commander (p. 113).

Drive Mode

You can set the drive mode, such as continuous or bracket shooting. This item is available in still image recording mode only.

- ▶ **Single Shooting**
Shoots 1 still image. Normal shooting mode.
- Cont. Shooting (📷)**
Shoots images continuously at high speed while you press and hold down PHOTO. Focus and brightness settings of the first shot are used for the following shots.
- Bracket: 0.3 EV ^{BRN}_(±0.3)**
Takes three photos, with different EV settings, each of which differs by 0.3 EV.
- Bracket: 0.7 EV ^{BRN}_(±0.7)**
Takes three photos, with different EV settings, each of which differs by 0.7 EV.

Note

- [Single Shooting] is always set when using the PHOTO button on the Wireless Remote Commander for shooting. Note that shooting may not be possible if it is difficult to focus on a subject.

AF Mode

Selects the focus method when PHOTO is pressed.

This item is available in still image recording mode only.

► Single-shot (AF-S)

The camcorder focuses and the focus is locked when you press PHOTO halfway down. Use this when the subject is motionless.



Continuous (AF-C)

The camcorder continues to focus while PHOTO is pressed and held halfway down. Use this when the subject is in motion.

⚡ Notes

- In movie recording mode, the camcorder automatically focuses appropriately to record movies.
- In [Continuous] mode, the audio signals will not sound when the subject is in focus.

SteadyShot

You can compensate for camera shake. Set [ SteadyShot] to [Off] () when using a tripod (sold separately), then the image becomes natural.

Available settings vary depending on the lens.

Active ()

Provides a more powerful SteadyShot effect.



► Standard

Provides a SteadyShot effect under relatively stable recording conditions.

Off ()

The SteadyShot function is not used.

SteadyShot

You can compensate for camera shake. Set [ SteadyShot] to [Off] () when using a tripod (sold separately), then the image becomes natural.

► On

The SteadyShot function is used.

Off ()

The SteadyShot function is not used.

Auto Back Light

Your camcorder adjusts the exposure for backlit subjects automatically.

► On

Adjusts the exposure for backlit subjects automatically.

Off

Does not adjust the exposure for backlit subjects.

MANUAL Button

You can select an item for adjustment with the MANUAL button. For details, see page 46.

Face Detection

You can set the camcorder to detect a face automatically. Furthermore, you can select which faces (children or adults) the camcorder detects with priority. It adjusts the focus/color/exposure automatically for the face of the selected subject. Also, it adjusts the image quality of face parts more finely, in the case of the high definition image quality (HD) movies.

► Auto

Detects faces without distinction between adults and children.

Child Priority ()

Gives faces of children priority.

Adult Priority ()

Gives faces of adults priority.

Off ()

Does not detect faces.

⚡ Notes

- Faces may not be detected depending on recording conditions, subject conditions, and the setting of your camcorder.

- [Face Detection] may not function properly depending on recording conditions. Set [Face Detection] to [Off] in this case.

Tips

- For better face detection performance, shoot the subject(s) under the following conditions:
 - Shoot in a sufficiently bright place
 - The subject(s) does not wear glasses, a hat or mask
 - The subject(s) faces directly towards the camera
- If you select a subject which has priority by touching the frame that has appeared around the subject's face, a double-lined frame will appear and that face has priority.

Flash

You can select the flash setting when shooting photos with a compatible external flash (sold separately).

▶ Auto

Flashes automatically when the camcorder judges the lack of light warrants a flash.

On

Flashes for every shot, regardless of ambient light.

Slow Sync.

Flashes for every shot. This setting makes not only the subject brighter, but also the background.

Rear Sync.

Flashes just before the exposure ends. Trails of moving objects follow their natural direction of movement.

Off

Does not flash

Flash Level

You can select the flash level when shooting photos with a compatible external flash (sold separately).

You can set a flash value from -3.0EV to +3.0EV on your camcorder. The set value may not be effective depending on the connected flash (sold separately).

Red Eye Reduction

A flash (sold separately) strobos 2 or more times before shooting to reduce the red-eye phenomenon.

This item is available in still image recording mode only.

▶ Off

Does not use Red Eye Reduction.

On

A flash always strobos to reduce the red-eye phenomenon.

Notes

- Turn on the power of a flash (sold separately) attached to use Red Eye Reduction.
- Red Eye Reduction may not produce the desired effects. It depends on individual differences and conditions, such as distance to the subject, or if the subject looked away from the pre-strobe.
- There are certain flash units that you cannot use with Red Eye Reduction. For the compatibility of a particular flash unit, consult your Sony dealer or local authorized Sony service facility.

Tips

- Pupils become dilated in dark environments. Flash light is reflected off the blood vessels at the back of the eye (retina), causing the “red-eye” phenomenon.



Wind Noise Reduct.

You can record a movie with less wind noise by cutting the low-frequency sound input from the built-in microphone.

- ▶ **Off**
Disables wind noise reduction.
- On** 
Enables wind noise reduction.

Audio Mode

You can change the recording sound format.

- 5.1ch Surround**  (5.1ch)
Records sound in 5.1ch surround.
- ▶ **2ch Stereo**  (2ch)
Records sound in 2ch stereo.

Audio Rec Level

You can adjust the volume when recording.

- Reset**
Returns to the normal level.

Tips

- We recommend that you use headphones to check the level when adjusting the setting.
- Set a lower level to naturally capture continuous loud sound. To capture quieter sound at an easy-to-hear level, increase this setting.
- The limiter is always working regardless of the Audio Rec Level setting.

Guide Frame

You can display the frame and check that the subject is horizontal or vertical. The frame is not recorded.

- ▶ **Off**
Does not display the guide frame.
- On**
Displays the guide frame.

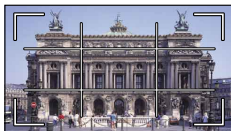

Tips

- Positioning the subject at the cross point of the guide frame makes a balanced composition.
- The outer frame of [Guide Frame] shows the display area of a TV which is not compatible with full pixel display.

Zebra

You can display a zebra pattern as a guide for adjusting brightness. The zebra pattern will not be recorded with the image.

- ▶ **Off**
Does not display the zebra pattern.

70 70

Displays the zebra pattern over the part of an image that exceeds the brightness level of about 70 IRE.

100 100

Displays the zebra pattern over the part of an image that exceeds the brightness level of about 100 IRE.

Note

- With a subject that exceeds a brightness level of 100 IRE, the image may become overexposed.

Tips

- IRE (Institute of Radio Engineers) is a measure of the video signal level that is used as the bases of brightness; the reference level (pedestal level) is set to 0 (%) and the maximum level (completely white level) is set to 100 (%).

Peaking

- ▶ **On/Off**
When you select [On], **PEAK W / PEAK R / PEAK Y** appears and you can display an image on the screen with its outlines enhanced. This function helps you to adjust the focus. The default setting is [Off].

Color

You can select peaking color from [White], [Red] and [Yellow]. The default setting is [White].

Level

You can select a peaking sensitivity from [High], [Middle] and [Low]. The default setting is [Middle].

Notes

- The outlines of the recorded images to the media are not enhanced.

Tips

- You can focus more easily using this function in combination with the expanded focus function (p. 42).

Histogram

You can display a histogram (graphic display of the distribution of tones within an image), to guide you when adjusting exposure. The histogram will not be recorded.

Off

Does not display the histogram.

On

Displays the histogram with a line indicating the brightness level 100.

On[Zebra Point]

Displays the histogram with lines indicating the brightness level set with [Zebra] (①) and the brightness level 100 (②).

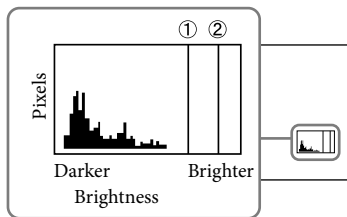

Tips

- The left area of the histogram represents darker areas of the picture, while the right represents brighter areas.

Camera Data Display

When you set this function to [On], you can display the iris, gain (ISO) and shutter speed settings on the screen. The default setting is [On].

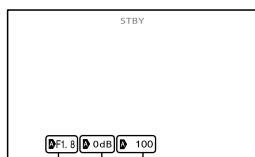

Iris value | Shutter speed value
Gain (ISO)

Tips

- The settings appear on the screen during the manual adjustment regardless of the settings of this function.
- A** indicates that the settings are automatically adjusted values.

Audio Level Display

You can select whether or not to display the audio level meter.

On

Displays the audio level meter.



Off

Does not display the audio level meter.

Tips

- When [Audio Mode] is set to [2ch Stereo], the 2 (left and right) audio level meters on the upper level move.



When you use the LA-EA2 and an A-mount lens, fine focus adjustment is possible. Perform this operation only when needed. Note that you may not be able to properly focus on a subject if you have made a poor adjustment.

▶ On/Off

When set to [On], registers the adjustment value for an attached lens and adjusts the focus by applying the registered value (default setting is [Off]).

Amount

Sets the adjustment value between -20 to +20 for the attached lens.

Clear All

Clears the values of all the registered lenses.

⚡ Notes

- When [AF Micro Adjustment] is not set to [On], you cannot register an adjustment value.
- By shifting the value toward +, the focus point shifts toward the background, and by shifting it toward -, the point shifts toward the foreground. Decide the value by reference to the result of a test shooting.
- We recommend that you decide the value under actual shooting conditions.
- When you attach a lens that is registered on the camera, the registered value is displayed. You can register up to 30 lenses. A message informing you of when this maximum has been reached will be displayed. To register any further lenses, you first need to delete already registered lenses. To do this, attach a lens to delete its registered value, then reset its value to "±0." Alternatively, you can reset the values of all lenses with [Clear All].
- If you perform AF fine adjustment with a lens of other manufacturers, the adjustment values of Sony, Minolta, and Konica Minolta lenses may be affected. Do not use this function with any lens of other manufacturers.
- You cannot individually perform AF fine adjustment when using the Sony, Minolta, and Konica Minolta lenses that have the same specifications.

Image Quality/Size (Items for setting up image quality or size)

See "Using menus" (p. 67) on the operation. The default settings are marked with ▶.

REC Mode

See page 43.

Frame Rate

You can select the frame rate to be used to record high definition image quality (HD) movies. Using [50i] is recommended for standard recording. Set [Frame Rate] first, before setting [REC Mode] (p. 43).

▶ 50i

For ordinary recording, this frame rate is recommended.

50p

You can record movies with a volume of data twice that of 50i with this setting, and this will allow you to enjoy clear images. When you play a movie recorded with this setting on a TV, the TV has to be compatible with 50p movie playback. If the TV is not compatible with 50p movie playback, the movie will be output as a 50i movie.

25p

This setting gives your movies a film-like appearance.

⚡ Notes

- The media that the recorded images can be saved on will depend on the recording mode that has been set during recording. For details, see page 43.

💡 Tips

- Frame rate means the number of images that are updated in a certain period of time.

See page 42.

Wide Mode

When recording standard definition image quality (STD) movies, you can select the horizontal to vertical ratio according to the TV connected. Refer also to the instruction manuals supplied with your TV.

▶ **16:9 WIDE**

Records movies to the full screen on a 16:9 (wide) TV screen.

4:3 (4:3)

Records movies to the full screen on a 4:3 TV screen.



Notes

- Set [TV Type] correctly according to the TV connected for playback (p. 83).

Image Size

You can select a size for the photos you are going to shot.

▶ **3:2** 16.0M (16.0M) 4,912 × 3,264**16:9** 13.6M (13.6M) 4,912 × 2,760**3:2** 8.4M (8.4M) 3,568 × 2,368**16:9** 7.1M (7.1M) 3,568 × 2,000**3:2** 4.0M (4.0M) 2,448 × 1,624**16:9** 3.4M (3.4M) 2,448 × 1,376**Notes**

- The selected image size is effective when the  (Photo) lamp is lit.
- See page 98 on the recordable number of photos.
- JPEG image size will be fixed at 16M when [ RAW/JPEG] is set to [RAW & JPEG].

Selects the compression format of still images.

▶ **JPEG**

This is a common compression format.

RAW

This format does not allow you to perform any digital processing on the images.

RAW+J (RAW & JPEG)

A RAW image and a JPEG image are created at the same time.

Tips• **RAW images**

The RAW format file is the raw data yet to go through any kind of digital processing. A RAW file is different from a more common file format such as JPEG in that it is the raw material to be processed for professional purposes.

You need the “Image Data Converter” software included on the CD-ROM (supplied) in order to open a RAW image recorded on this camera. With this software, a RAW image can be opened and converted to a common format, such as JPEG or TIFF, and its white balance, color saturation, contrast, etc., can be readjusted.



Edit/Copy

(Items for editing)

See “Using menus” (p. 67) on the operation.

Delete

See page 50.

Protect

See page 51.

Copy

See page 62.

Direct Copy

See page 63.



Setup

(Other setup items)

See “Using menus” (p. 67) on the operation. The default settings are marked with ►.

Media Info



You can check the remaining recordable time for each recording mode of the memory card for movies and the approximate free and used media space.

To turn off the display

Touch

Notes

- Since there is a management file area, the used space is not displayed as 0 % even if you perform [Format] (p. 82).

Tips

- The camcorder can display the information of the memory card.

Format



Formatting deletes all the movies and photos to recover recordable free space. Select the media to be formatted, touch

→

Notes

- Connect your camcorder to the wall outlet (wall socket) using the supplied AC Adaptor for this operation (p. 16).
- To avoid the loss of important images, you should save them before formatting the recording media.
- Protected movies and photos will also be deleted.
- While [Executing...] is displayed, do not close the LCD screen, operate the buttons on the camcorder, disconnect the AC Adaptor, or eject the memory card from your camcorder. (The access lamp is lit or flashing while formatting memory card.)



See page 92, 95.



You can select the way to assign file number of photos.

► Series

Assigns file numbers of photos in sequence. The file number becomes larger each time you record a photo.

Even if the memory card is replaced with another one, the file number is assigned in sequence.

Reset

Assigns file numbers in sequence, following the largest file number existing on the memory card.

When the memory card is replaced with another one, the file number is assigned for each memory card.



During playback, your camcorder displays the information (Date/Time, Camera Data) recorded automatically at the time of recording.

► Off

Data code is not displayed.

Date/Time

Displays the date and time.

Camera Data

Displays camera setting data.

Date/Time

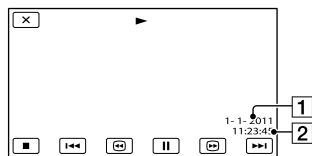

1 Date

2 Time

Camera Data

Movie

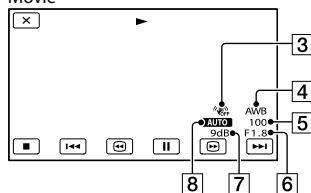

Photo

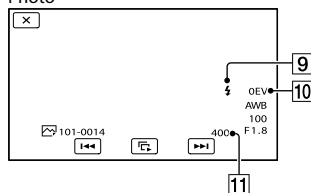

3 SteadyShot off

4 White Balance

5 Shutter Speed

6 IRIS (Aperture value)

7 Gain

8 Brightness

9 Flash

10 Exposure compensation

11 ISO

💡 Tips

- The data code is displayed on the TV screen if you connect your camcorder to a TV.
- The indicator toggles through the following sequences as you press DATA CODE on the Wireless Remote Commander: [Date/Time] → [Camera Data] → [Off] (no indication).
- Depending on the memory card condition, bars [---:---] appear.



You can adjust the volume of playback sound by touching / .



You need to convert the signal depending on the TV connected when playing back movies and photos. The recorded movies

and photos are played back as following illustrations.

▶ 16:9

Select this to view your movies on a 16:9 (wide) TV. The recorded movies and photos are played back as shown below.

Movies and photos recorded in 16:9 (wide) mode Movies and photos recorded in 4:3 mode



4:3

Select this to view your movies and photos on a 4:3 standard TV. The recorded movies and photos are played back as shown below.

Movies and photos recorded in 16:9 (wide) mode Movies and photos recorded in 4:3 mode



⚡ Notes

- Horizontal to vertical ratio of high definition image quality (HD) movies is 16:9.

Component Output



Select [Component] when connecting your camcorder to a TV with the component input jack.

1080p/576i

Select this when connecting your camcorder to a TV that has the component input jack and is capable of displaying the 1080p signal.

▶ 1080i/576i

Select this when connecting your camcorder to a TV that has the component input jack and is capable of displaying the 1080i signal.

576i

Select this when connecting your camcorder to a TV with the component input jack.

HDMI Resolution



Select the output image resolution when connecting your camcorder to a TV with an HDMI cable (sold separately).

▶ Auto

Normal setting (outputs the signal according to the TV automatically).

1080p/576p

Outputs high definition image quality (HD) movies with a 1080p signal and standard image quality (STD) movies with a 576p signal.

1080i/576i

Outputs high definition image quality (HD) movies with a 1080i signal and standard image quality (STD) movies with a 576i signal.

720p/576p

Outputs high definition image quality (HD) movies with a 720p signal and standard image quality (STD) movies with a 576p signal.

576p

Outputs the 576p signal.

576i

Outputs the 576i signal.

⚡ Notes

- When [Frame Rate] is set to [50p] and [HDMI Resolution] is set to [720p/576p] or [576p], HDMI signals cannot be output during recording.

CTRL FOR HDMI (Control for HDMI)



When connecting your camcorder to a "BRAVIA" Sync compatible TV with an HDMI cable (sold separately), you can play back movies on your camcorder by aiming

the TV's Remote Commander at the TV (p. 40).

► On

Operates your camcorder using the TV's Remote Commander.

Off

Does not operate your camcorder using the TV's Remote Commander.

USB Connect

Select this item when [USB Select] does not appear on the LCD screen by connecting the camcorder to a computer with the USB cable.

See page 64.

USB Connect Setting

You can set the USB transfer mode for connecting the camcorder to a computer or other USB device.

► Auto

The camcorder automatically selects the USB transfer mode depending on the connected device.

Mass Storage

This is a USB transfer mode compatible to many types of USB devices.

MTP

This is a USB transfer mode compatible with certain types of computers.

 Notes

- When you connect the camcorder to other devices using the [MTP] mode, movies that have been recorded with the same image quality as the one currently selected (selected with the [HDMI/STDB] Setting) menu can only be displayed on the connected device.
- When the camcorder is connected to an external device in the [MTP] mode, movie files will be displayed with the recorded date, however, some information, such as area information, included in the movie files cannot be displayed on the connected device.

To import images from the camcorder to your computer, use the supplied "PMB" software.

- If the "Device Stage*" window does not open when you connect the camcorder to a computer equipped with Windows 7, set [USB Connect Setting] to [Auto].

* "Device Stage" is a menu of Windows 7, that is used to manage devices (camcorder, camera, etc.) that are connected to the computer.

Disc Burn

See page 55.

Beep

► On

A melody sounds when you start/stop recording, or operate the touch panel.

Off

Cancels the melody.

LCD Brightness

You can adjust the brightness of the LCD screen.

► Normal

Normal setting (normal brightness).

Bright

Select this when the LCD screen is not bright enough.

 Tips

- This adjustment does not affect the recorded images in any way.
- The brightness is set to [Bright] automatically when using the AC Adaptor.

VF Brightness

You can adjust the brightness of the viewfinder.

► Normal

Standard brightness.

Bright

Brightens the viewfinder screen.

⚙️ Notes

- The brightness is set to [Bright] automatically when using the AC Adaptor.
- When you select [Bright], the recordable time with the battery is slightly reduced.

Display Setting

You can set the duration of displaying the icons or indicators on the LCD screen.

▶ Auto

Displays for about 3 seconds. The rec button on the LCD screen is displayed when shooting.

On

Always displays. The rec button on the LCD screen is not displayed when shooting.

💡 Tips

- The icons or indicators are displayed in the following cases.
 - When you turn on your camcorder.
 - The LCD screen is touched (Except rec button on LCD screen).
 - When you switch your camcorder to the movie recording, photo recording, or playback mode.
- You can switch the display by pressing DISPLAY.

REC Lamp (Recording lamp)

You can make the camera recording lamp on the front of your camcorder not to turn on.

▶ On

The camera recording lamp lights up.

Off

The camera recording lamp does not light up.

Shooting w/o Lens

Sets whether or not the recording can be started when no lens is attached.

▶ Disable

Recording starts only when a lens is attached.

Enable

Allows you to use non-Sony E-mount lenses and mount adaptors.

Remote Ctrl (Remote control)

▶ On

Select this when you use the supplied Wireless Remote Commander (p. 113).

Off

Select this if you do not intend to use the supplied Wireless Remote Commander.

💡 Tips

- Select [Off] when you want to prevent your camcorder from responding to a command sent by another remote control unit.

A. Shut Off (Auto shut off)

You can set your camcorder to turn off automatically when you do not operate your camcorder for more than about 5 minutes.

▶ On

The camcorder turns off automatically.

Off

The camcorder does not turn off automatically.

⚙️ Notes

- The camcorder does not turn off automatically when using the AC Adaptor.

Language Setting

You can select the language to be used on the LCD screen.

💡 Tips

- Your camcorder offers [ENG[SIMP]] (simplified English) for when you cannot find your native tongue among the options.

Calibration

See page 104.

Battery Info

You can check the estimated remaining capacity of the battery.
Touch  in upper left on the screen.

Version

You can see the version of the lens and your camcorder. You can use this function when the firmware update of your camcorder was released.

Note

- You should update only when using the AC Adaptor. Otherwise, we recommend using a fully charged battery.
- The version of the lens may not be displayed in any mode other than shooting mode.

Date & Time Setting

■ Date & Time Format

You can select one from 4 types of date and time format.

■ Summer Time

You can change this setting without stopping the clock. Set to [On] to move the time forward 1 hour.

▶ Off

Does not set the summertime.

On

Sets the summertime.

■ Date & Time

See page 23.

Area Setting

You can adjust a time difference without stopping the clock. Select your local area when using the camcorder in other time zones. Refer to the world time difference information on page 100.

▶ Home

Select this item when you are going to use the camcorder in the area where you are living.

Destination

Select this item when you want to use the camcorder with the area setting set to another place.

Tips

- If you visit a certain place often and want to use the camcorder with the area setting set to that place, it is useful if you set the place to [Destination].

? Troubleshooting

If you run into any problems using your camcorder, follow the steps below.

- 1 Check the list (p. 88 to 96), and inspect your camcorder.

- 2 Disconnect the power source, attach the power source again after about 1 minute, and turn the camcorder on.

- 3 Press RESET (p. 111) using a pointed object, and turn the camcorder on. If you press RESET, all settings, including the clock setting, are reset.

- 4 Contact your Sony dealer or local authorized Sony service facility.

- Overall operations/Wireless Remote Commander..... p. 88
- Batteries/power sources p. 89
- LCD screen/viewfinder p. 89
- Memory card p. 90
- Recording..... p. 90
- Playback p. 92
- Playing back images stored on memory card on other devices..... p. 92
- Editing movies/photos on your camcorder. p. 92
- Playback on the TV p. 93
- Copying/Connecting to other devices p. 93
- Connecting to a computer p. 93

Overall operations/Wireless Remote Commander

The power does not turn on.

- Attach a charged battery pack to the camcorder (p. 15).
- The plug of the AC Adaptor has been disconnected from the wall outlet (wall

socket). Connect it to the wall outlet (wall socket) (p. 15).

The camcorder does not operate even when the power is set to on.

- It takes a few seconds for your camcorder to be ready to shoot after the power is turned on. This is not a malfunction.
- Disconnect the AC Adaptor from the wall outlet (wall socket) or remove the battery pack, then reconnect it after about 1 minute. If the functions still do not work, press RESET (p. 111) using a pointed object. (If you press RESET, all settings, including the clock setting, are reset.)
- The temperature of your camcorder is extremely high. Turn off your camcorder and leave it for a while in a cool place.
- The temperature of your camcorder is extremely low. Leave your camcorder with the power of your camcorder on. Turn off your camcorder and take it to a warm place. Leave the camcorder there for a while, then turn on your camcorder.

Your camcorder gets warm.

- Your camcorder may become warm during operation. This is not a malfunction.

The supplied Wireless Remote Commander does not function.

- Set [Remote Ctrl] to [On] (p. 86).
- Insert a battery into the battery holder with the +/- polarities correctly matching the +/- marks (p. 114).
- Remove any obstructions between the Wireless Remote Commander and the remote sensor.
- The Wireless Remote Commander will also not work if the remote sensor (p. 112) is obstructed by the lens.
- Point the remote sensor away from strong light sources such as direct sunlight or overhead lighting. Otherwise, the Wireless Remote Commander may not function properly.

Another DVD device malfunctions when you use the supplied Wireless Remote Commander.

- Select a commander mode other than DVD 2 for your DVD device, or cover the sensor of your DVD device with black paper.

Batteries/power sources

The battery pack cannot be attached to your camcorder.

- Use an “InfoLITHIUM” battery pack (V series). You cannot use NP-FV30/FV50, even though they are V series.

The power abruptly turns off.

- Use the AC Adaptor.
- In the default setting, when about 5 minutes have elapsed while you do not operate your camcorder, the camcorder is automatically turned off (A. Shut Off). Change the setting of [A. Shut Off] (p. 86), or turn on the power again.
- Charge the battery pack (p. 15).

The CHG (charge) lamp does not light while the battery pack is being charged.

- Turn off the power (p. 15).
- Attach the battery pack to the camcorder correctly (p. 15).
- Connect the power cord (mains lead) to the wall outlet (wall socket) properly.
- The battery charge is completed (p. 15).

The CHG (charge) lamp flashes while the battery pack is being charged.

- If the temperature of the battery pack is too high or too low, you may not be able to charge it (p. 102).
- Attach the battery pack to the camcorder correctly (p. 15). If the problem persists, disconnect the AC Adaptor from the wall outlet (wall socket) and contact your Sony dealer. The battery pack may be damaged.

The remaining battery time indicator does not indicate the correct time.

- The ambient temperature is too high or too low. This is not a malfunction.
- The battery pack has not been charged enough. Fully charge the battery again. If the problem persists, replace the battery pack with a new one (p. 103).
- The indicated time may not be correct depending on the environment of use.

The battery pack is quickly discharged.

- The ambient temperature is too high or low. This is not a malfunction.
- The battery pack has not been charged enough. Fully charge the battery again. If the problem persists, replace the battery pack with a new one (p. 103).

LCD screen/viewfinder

Nothing is displayed on the viewfinder or LCD monitor when the power is turned on.

- The camcorder displays images on the viewfinder or the LCD monitor. You can switch between the viewfinder and the LCD monitor by pressing FINDER/LCD.

Menu items are grayed out.

- You cannot select grayed items in the current recording/playback situation.
- There are some functions you cannot activate simultaneously.

The buttons do not appear on the touch panel.

- Touch the LCD screen lightly.
- Press DISPLAY on your camcorder, or DISPLAY on the Wireless Remote Commander (p. 113).

The buttons on the touch panel do not work correctly or do not work at all.

- Adjust the touch panel ([Calibration]) (p. 104).

The image in the viewfinder is not clear.

- Move the viewfinder lens adjustment lever until the image appears clearly (p. 26).

Red, blue or green flickering in the viewfinder.

- You may see colors (red, blue, green) shimmering in the viewfinder when you move your line of sight. This is not a malfunction. The shimmering colors will not be recorded on the memory card.

Memory card

Operations using the memory card cannot be performed.

- If you use the memory card formatted on a computer, format it again on your camcorder (p. 82).

Images stored on the memory card cannot be deleted.

- The maximum number of images that you can delete on the index screen at one time is 100.
- You cannot delete the protected images.



The data file name is not indicated correctly or flashes.

- The file is damaged.
- The file format is not supported by your camcorder (p. 102).

Recording

Refer also to "Memory card" (p. 90).

Pressing START/STOP or PHOTO does not record images.

- The playback screen is displayed. Press MODE to turn on the  (Movie) or  (Photo) lamp (p. 31).
- Your camcorder is recording the image you have just shot on the memory card. You cannot make new recording during this period.

- The memory card is full. Delete unnecessary images (p. 50).
- Total number of movie scenes or photos exceeds the recordable capacity of your camcorder. Delete unnecessary images (p. 50).
- The temperature of your camcorder is extremely high. Turn off your camcorder and leave it for a while in a cool place.
- The temperature of your camcorder is extremely low. Turn off your camcorder and take it to a warm place. Leave the camcorder there for a while, then turn on the camcorder.
- The lens is not attached correctly. Reattach the lens.

The access lamp remains lit or flashing even if recording was stopped.

- Your camcorder is recording the scene you have just shot on the memory card.

The imaging field looks different.

- The imaging field may look different depending on the condition of your camcorder. This is not a malfunction.

The actual recording time for movies is less than the expected recording time of the recording media.

- Depending on the recording conditions, the time available for recording may be shorter, for example when recording a fast moving object, etc (p. 97).

The camcorder stops operating.

- The temperature of your camcorder is extremely high. Turn off your camcorder and leave it for a while in a cool place.
- The temperature of your camcorder is extremely low. Turn off your camcorder and take it to a warm place. Leave the camcorder there for a while, then turn on the camcorder.

There is a time difference between the point when START/STOP is pressed and the point that the recording movie is started or stopped actually.

- On your camcorder, there may be a slight time difference between the point where you

press START/STOP and the actual point that recording movie starts/stops. This is not a malfunction.

Photo shooting is slow.

- The noise reduction function is working. This is not a malfunction.



The horizontal to vertical ratio of the movie (16:9 (wide)/4:3) cannot be changed.

- The horizontal to vertical ratio of high definition image quality (HD) movies is 16:9 (wide).

The auto focus does not function.

- The subject is too close. Check the minimum shooting distance of the lens.
- Ambient light is insufficient.
- The recording conditions are not suitable for auto focus. Adjust the focus manually (p. 41).

SteadyShot does not function.

- Attach a lens compatible with the SteadyShot function.
- Set [ SteadyShot] to [Active] or [Standard], [ SteadyShot] to [On] (p. 76).

Flash shooting cannot be done.

- Turn on the external flash (sold separately).
- The flash is not attached correctly. Reattach the flash.
- The flash cannot be used for movie shooting.

Fuzzy white circular spots appear on images shot using a flash.

- Particles (dust, pollen, etc.) in the air reflected the flash light and appeared on the image. This is not a malfunction.

The image taken with flash is too dark.

- If the subject is beyond the flash range (the distance that the flash can reach), the pictures will be dark because the flash light does not reach the subject. If the ISO is changed, the flash range also changes with it.

The subjects passing by the screen very fast appear crooked.

- This is called the focal plane phenomenon. This is not a malfunction. Because of the way the image device (CMOS sensor) reads out image signals, the subjects passing by the lens rapidly might appear crooked depending on the recording conditions.

Horizontal stripes appear on the images.

- This occurs when recording images under a fluorescent lamp, sodium lamp, or mercury lamp. This is not a malfunction.
- It may be eliminated by adjusting Shutter Speed.

Black bands appear when you record a TV screen or computer screen.

- Adjust Shutter Speed (p. 47).

[LCD Brightness] cannot be adjusted.

- You cannot adjust [LCD Brightness] when:
 - The LCD panel is closed on your camcorder with the LCD screen facing out.
 - The power is supplied from the AC Adaptor.

The iris and/or shutter speed icon blinks when you press PHOTO halfway.

- Since the subject is too bright or too dark, it is beyond the available range of the camcorder. Adjust the setting again.

The image is washed out (Flaring) Light glare appears on the image (Ghosting)

- This can occur when shooting backlit subjects. When using the zoom lens, attach the lens hood.

The corners of the image are dark.

- Remove the filter or hood. Depending on the thickness of the filter or improper attachment of the hood, the filter or the hood may partially appear in the image. The optical properties of some lenses may cause the periphery of the image to appear too dark (insufficient light).

Sound is not recorded correctly.

- If you disconnect an external microphone, etc. during recording movies, sound may not be recorded correctly.
- Connect the microphone again in the same way as when you start recording movies.
- No sound will be recorded if Audio Rec Level (p. 78) is set to minimum.

Playback

Images cannot be played back.

- Select the image quality of the movie you want to play back (p. 42).
- Images recorded on other devices may not be played back. This is not a malfunction.

Photos cannot be played back.

- Photos cannot be played back if you have modified files or folders, or have edited the data on a computer. (The file name flashes in that case.) This is not a malfunction.

is indicated on a thumbnail.

- This may appear on an image recorded on other devices, edited on a computer, etc.
- You removed the AC Adaptor or the battery pack while the memory card icon at the top right corner of the screen flashes, or before the access lamp is turned off after recording. This may damage your image data and  is displayed.

is indicated on a thumbnail.

- The image data base file may be damaged. Check the data base file by touching **MENU** (MENU) → [Setup] → [Repair Img. DB F.]. If it still appears, delete the image with  (p. 50).

No sound or only a quiet sound is heard during playback.

- Turn up the volume (p. 36).

Left and right sound will be heard unbalanced when playing back movies on computers or other devices.

- This happens when sound recorded in 5.1ch surround is converted to 2ch (normal stereo sound) by a computer or other device. This is not a malfunction.
- Change the sound conversion type (downmix type) when playing back on 2ch stereo devices. Refer to the instruction manual supplied with your playback device for details.
- Change the sound to 2ch when creating a disc using the supplied software "PMB"
- Record sound with [Audio Mode] set to [2ch Stereo] (p. 78).

Playing back images stored on memory card on other devices

Images cannot be played back or the memory card is not recognized.

- The playback device does not support playing back memory cards (p. 4).

Editing movies/photos on your camcorder

Unable to edit.

- Unable to edit because of the condition of the image.

A movie cannot be divided.

- A movie that is too short cannot be divided.
- A protected movie cannot be divided.

A photo cannot be captured from a movie.

- The memory card where you want to save photos is full.

Neither image nor sound is played on the connected TV.

- When you are using the component A/V cable, set [Component] according to the requirements of the connected device (p. 84).
- When you are using the component video plug, make sure the red and white plugs of the A/V connecting cable are connected (p. 38).
- Images are not output from the HDMI OUT jack, if copyright protection signals are recorded in the images.
- When you are using the S VIDEO plug, make sure the red and white plugs of the A/V connecting cable are connected (p. 39).

The top, bottom, right, and left edges of images are trimmed slightly on a connected TV.

- The LCD screen of your camcorder can display recording images across the entire screen (full pixel display). However, this may cause slight trimming of the top, bottom, right, and left edges of images when played back on a TV which is not compatible with full pixel display.
- It is recommended you record images using the outer frame of [Guide Frame] (p. 78) as a guide.

The image appears distorted on the 4:3 TV.

- This happens when viewing an image recorded in the 16:9 (wide) mode on a 4:3 TV. Set [TV Type] correctly (p. 83) and play back the image.

Black bands appear at the top and bottom of the screen of the 4:3 TV.

- This happens when viewing an image recorded in the 16:9 (wide) mode on a 4:3 TV. This is not a malfunction.

Images are not copied correctly.

- You cannot copy images using the HDMI cable (sold separately).
- The A/V connecting cable is not connected properly. Make sure to connect the cable to the input jack of another device (p. 65).

“PMB” cannot be installed.

- Check the computer environment or installation procedure required to install “PMB.”

“PMB” does not work correctly.

- Quit “PMB” and restart your computer.

The camcorder is not recognized by the computer.

- Disconnect devices from the USB jack of the computer other than the keyboard, mouse, and your camcorder.
- Disconnect the USB cable (supplied) from the computer and your camcorder, and restart the computer, then connect the computer and your camcorder again in the correct order.

Self-diagnosis display/ Warning indicators

If indicators appear on the LCD screen or viewfinder, check the following.

If the problem persists even after you have tried to fix a couple of times, contact your Sony dealer or local authorized Sony service facility. In this case, when you contact them, give them all the numbers of the error code beginning with C or E.

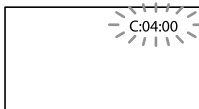

C:(or E:) □□:□□ (Self-diagnosis display)

C:04:□□

- The battery pack is not an “InfoLITHIUM” battery pack (V series). Use an “InfoLITHIUM” battery pack (V series) (p. 102).
- Connect the DC plug of the AC Adaptor to the DC IN jack of your camcorder securely (p. 15).

C:06:□□

- The battery pack temperature is high. Change the battery pack or place it in a cool place.

C:13:□□ / C:32:□□

- Remove the power source. Reconnect it and operate your camcorder again.

E:□□:□□

- Follow the steps from ② on page 88.

(Battery level warning)

- The battery pack is nearly used up.
- Depending on the operating environment or battery conditions, may flash, even if there are about 20 percent of remaining battery charge.

(Warning indicator pertaining to battery pack temperature)

- The battery pack temperature is high. Change the battery pack or place it in a cool place.

(Warning indicator pertaining to memory card)

Slow flashing

- Free spaces for recording images are running out. For the type of memory card you can use with your camcorder, see page 29.
- No memory card is inserted (p. 29).

Fast flashing

- There are not enough free spaces for recording images. After storing the images on other media (p. 59), delete unnecessary images, or format the memory card (p. 82).
- The image data base file may be damaged. Check the data base file by touching **MENU** (MENU) → [Setup] → [Repair Img. DB F].
- The memory card is damaged.

(Warning indicators pertaining to memory card formatting)

- The memory card is damaged.
- The memory card is not formatted correctly (p. 82).

(Warning indicator pertaining to incompatible memory card)

- Incompatible memory card is inserted (p. 29).

(Warning indicator pertaining to the write-protect of the memory card)

- The memory card is write-protected.
- Access to the memory card was restricted on another device.

(Warning indicator pertaining to the external media device)

- The image database file may be damaged. Check the database file by touching **MENU** (MENU) → [Setup] → [Repair Img. DB F].
- The external media device is damaged.

(Warning indicator pertaining to formatting of the external media device)

- The external media device is damaged.
- The external media device is not formatted correctly.

 (Warning indicator pertaining to camera-shake warning)

- The camcorder is unsteady, so camera-shake easily occurs. Hold the camcorder steady with both hands and record the image. However, note that the camera-shake warning indicator does not disappear.

 (Warning indicator pertaining to photo recording)

- The memory card is full.
- Photos cannot be recorded during processing. Wait for a while, then record.

Tips

- You may hear a melody when some warning indicators appear on the screen.

Description of warning messages

If messages appear on the screen, follow the instructions.

Recording media

Data error.

- This may occur when you false access of a memory card.
- Movies recorded on other devices may not be played back.

Inconsistencies found in image database file. Do you want to repair the image database file?

Inconsistencies found in image database file. Cannot record or play HD movies. Do you want to repair the image database file?

- You cannot record or play back movies because no movie management information exists. If you touch , new management information is created and you can record or play back movies.

Inconsistencies found in the image database file. Back up and recover. Recover, then import using the included PC software.

- Since the database information of high definition image quality (HD) movies has been damaged, there are inconsistencies between the information in the database and the information in the file. Touch  to back up the high definition image quality (HD) movies and repair the database file. You cannot see the backed-up movies on the camcorder.

By connecting the camcorder to a computer after repairing the database, you can import backed-up high definition image quality (HD) movies to the computer using the supplied “PMB” software installed on the computer. However, it is not guaranteed that all movies can be imported to the computer.

Buffer overflow. Writing to the media was not completed in time.

- You have performed recording and erasing operations repeatedly, or a memory card that has been formatted by other device is used. Copy and take data backup to other device (such as a computer), and then format the memory card on the camcorder (p. 82).
- The size of the inserted memory card is not sufficient for copying the movie(s). Use the recommended memory card (p. 29).

Recovering data.

- Your camcorder tries to recover data automatically if the data writing was not performed properly.

Cannot recover data.

- Writing data onto the media of the camcorder has failed. Attempts were made to recover the data, but they were unsuccessful.

Reinsert the memory card.

- Reinsert the memory card a few times. If even then the indicator flashes, the memory card could be damaged. Try with another memory card.

 Cannot recognize this memory card. Format and use again.

- Format the memory card (p. 82). Note that if you format the memory card, all the recorded movies and photos are deleted.

 Still picture folder is full. Cannot record still pictures.

- You cannot create folders exceeding 999MSDCF. You cannot create or delete created folders using your camcorder.
- Format the memory card (p. 82), or delete folders using your computer.

This memory card may not be able to record or play movies.

- Use a memory card recommended for your camcorder (p. 29).

This memory card may not be able to record or play images correctly.

- Use a memory card recommended for your camcorder (p. 29).

Do not eject the memory card during writing. Data may be damaged.

- Reinsert the memory card, and follow the instructions on the LCD screen.

External media cannot execute functions.

- Check the database file by touching **MENU** (MENU) → [Setup] → [Repair Img. DB F].
- If the message still appears, reconnect the external media device, then format it. Note that if you format the external media device, all the recorded movies and photos are deleted.
- If you cannot format the external media device, the external media device may be incompatible with your camcorder, or damaged. Replace it with a new one.

Unable to access external media.

- Use the external media device in stable condition (the environment such as no vibration and room temperature, etc.).
- Make sure to the power source of the external media device is connected.

Cannot recognize the lens. Attach the lens properly.

- The lens is not attached correctly or the lens is not attached. If the message appears when a lens is attached, reattach the lens. If the message appears frequently, check whether the contacts of the lens and camcorder are clean or not.
- When attaching a non-Sony E-mount lens or mount adaptor, set [Shooting w/o Lens] to [Enable].

Other

Maximum number of images already selected.

- You can select only 100 images at one time for:
 - Deleting movies/photos
 - Protecting movies/photos, or releasing the protection
 - Copying movies/photos

Data protected.

- You tried to delete protected data. Release the protection of the data.

Recording time of movies/number of recordable photos

“HD” stands for high definition image quality, and “STD” stands for standard image quality.

Expected time of recording and playback with each battery pack

Recording time

Approximate time available when you use a fully charged battery pack.

Battery pack	(unit: minute)			
	Continuous recording time		Typical recording time	
Image quality	HD	STD	HD	STD
NP-FV70 (supplied)	175	185	95	100
	190	205	105	110
NP-FV100	350	370	190	205
	385	405	210	220

- Top: When recording with the LCD screen
Bottom: When recording with viewfinder
- Each recording time is measured under the following conditions.
 - [REC Mode]: Standard **HQ** (default setting)
 - Using E 18-200mm F3.5-6.3 OSS lens
- Typical recording time shows the time when you repeat recording start/stop, switching the MODE lamp, and zooming.
- Times measured when using the camcorder at 25 °C (77 °F). 10 °C to 30 °C (50 °F to 86 °F) is recommended.
- The recording and playback time will be shorter when you use your camcorder in low temperatures.
- The recording and playback time will be shorter depending on the conditions under which you use your camcorder.

Playing time

Approximate time available when you use a fully charged battery pack.

Battery pack	(unit: minute)	
	HD	STD
Image quality		
NP-FV70 (supplied)	325	355
	415	440
NP-FV100	650	710
	830	870

- Top: When recording with the LCD screen
Bottom: When recording with viewfinder

Expected recording time of movies

High definition image quality (HD)

	(unit: minute)				
	2 GB	4 GB	8 GB	16 GB	32 GB
PS	9 (9)	15 (15)	35 (35)	75 (75)	150 (150)
FX	10 (10)	20 (20)	40 (40)	90 (90)	180 (180)
FH	10 (10)	30 (30)	60 (60)	120 (120)	245 (245)
HQ	25 (20)	50 (40)	105 (80)	215 (165)	440 (330)
LP	45 (35)	90 (75)	190 (155)	380 (310)	770 (630)

Standard definition image quality (STD)

	(unit: minute)				
	2 GB	4 GB	8 GB	16 GB	32 GB
HQ	25 (25)	55 (50)	110 (100)	225 (210)	460 (420)

- When [Audio Mode] is set to 2ch (p. 78).

Notes



- When using Sony memory card.
- The recordable time may vary depending on the recording and subject conditions and [REC Mode] and [Frame Rate] (p. 80).
- The number in () is the minimum recordable time.

Tips

- Your camcorder uses the VBR (Variable Bit Rate) format to automatically adjust image quality to suit the recording scene. This technology causes fluctuations in the recording time of the media. Movies containing quickly moving and complex images are recorded at a higher bit-rate, and this reduces the overall recording time.

Expected number of recordable photos

	JPEG	RAW	RAW & JPEG
2 GB	295	105	80
4 GB	590	215	155
8 GB	1150	440	320
16 GB	2400	880	640
32 GB	4800	1750	1250

- When [ Image Size] is set to [ 16.0M].
- When using Sony memory card.
- The selected image size is effective when the  (Photo) lamp is lit.
- The number of recordable photos of memory card shown is for the maximum image size of your camcorder. The actual number of recordable photos is displayed on the LCD screen during recording (p. 108).
- The number of recordable photos of memory card may vary depending on the recording conditions.

Tips

- You can also use memory card with a capacity of under 1 GB for recording photos.
- The following list shows the bit-rate, pixels and aspect ratio of each recording mode (movie + audio, etc.).
 - High definition image quality (HD):
 - PS: Max. 28 Mbps 1,920 × 1,080 pixels/16:9
 - FX: Max. 24 Mbps 1,920 × 1,080 pixels/16:9
 - FH: Approx. 17 Mbps (average) 1,920 × 1,080 pixels/16:9
 - HQ: Approx. 9 Mbps (average) 1,440 × 1,080 pixels/16:9
 - LP: Approx. 5 Mbps (average) 1,440 × 1,080 pixels/16:9
 - Standard definition image quality (STD):
 - HQ: Approx. 9 Mbps (average) 720 × 576 pixels/16:9, 4:3
- The photo recording pixels and the aspect ratio.
 - Photo recording mode:
 - 4,912 × 3,264 dots/3:2
 - 4,912 × 2,760 dots/16:9
 - 3,568 × 2,368 dots/3:2
 - 3,568 × 2,000 dots/16:9
 - 2,448 × 1,624 dots/3:2
 - 2,448 × 1,376 dots/16:9
 - Capturing a photo from a movie:
 - 1,920 × 1,080 dots/16:9
 - 640 × 360 dots/16:9
 - 640 × 480 dots/4:3

Using your camcorder abroad

Power supply

You can use your camcorder in any countries/regions using the AC Adaptor supplied with your camcorder within the AC 100 V to 240 V, 50 Hz/60 Hz range.

Viewing high definition image quality (HD) movies

In countries/regions where 1080/50i is supported, you can view the movies with the same high definition image quality (HD) as that of the recorded movies. You need a PAL-system-based and 1080/50i compatible TV (or monitor) with component and AUDIO/VIDEO input jacks. A component A/V cable or an HDMI cable (sold separately) must be connected.

Viewing standard definition image quality (STD) movies

To view standard definition image quality (STD) movies, you need a PAL-system-based TV with AUDIO/VIDEO input jacks. An A/V connecting cable must be connected.

On TV color systems

Your camcorder is a PAL-system-based camcorder. If you want to view the playback image on a TV, it must be a PAL-system-based TV with an AUDIO/VIDEO input jack.

System	Used in
PAL	Australia, Austria, Belgium, China, Czech Republic, Denmark, Finland, Germany, Holland, Hong Kong, Hungary, Italy, Kuwait, Malaysia, New Zealand, Norway, Poland, Portugal, Singapore, Slovak Republic, Spain, Sweden, Switzerland, Thailand, United Kingdom, etc.

System	Used in
PAL-M	Brazil
PAL-N	Argentina, Paraguay, Uruguay
NTSC	Bahama Islands, Bolivia, Canada, Central America, Chile, Colombia, Ecuador, Guyana, Jamaica, Japan, Korea, Mexico, Peru, Surinam, Taiwan, the Philippines, the USA, Venezuela, etc.
SECAM	Bulgaria, France, Guiana, Iran, Iraq, Monaco, Russia, Ukraine, etc.

Setting to the local time

You can easily set the clock to the local time by setting a time difference when using your camcorder abroad. Touch **MENU** (MENU) → [Setup] → [⌚ (⌚ Clock Settings)] → [Date & Time Setting] → [Summer Time] and **MENU** (MENU) → [Setup] → [⌚ (⌚ Clock Settings)] → [Area Setting] (p. 87).

World time difference

Time-zone differences	Area setting
GMT	Lisbon, London
+01:00	Berlin, Paris
+02:00	Helsinki, Cairo, Istanbul
+03:00	Nairobi
+03:30	Tehran
+04:00	Moscow, Abu Dhabi, Baku
+04:30	Kabul
+05:00	Karachi, Islamabad
+05:30	Calcutta, New Delhi
+06:00	Almaty, Dhaka
+06:30	Yangon
+07:00	Bangkok, Jakarta
+08:00	Hong Kong, Singapore, Beijing
+09:00	Seoul, Tokyo
+09:30	Adelaide, Darwin
+10:00	Melbourne, Sydney
+11:00	Solomon Is
+12:00	Fiji, Wellington, Eniwetok, Kwajalein

Time-zone differences	Area setting
-11:00	Samoa
-10:00	Hawaii
-09:00	Alaska
-08:00	Los Angeles, Tijuana
-07:00	Denver, Arizona
-06:00	Chicago, Mexico City
-05:00	New York, Bogota
-04:00	Santiago
-03:30	St. John's
-03:00	Brasilia, Montevideo
-02:00	Fernando de Noronha
-01:00	Azores, Cape Verde Is.

Maintenance and precautions

About the AVCHD format

What is the AVCHD format?

The AVCHD format is a high definition digital video camera format used to record a high definition (HD) signal using efficient data compression coding technology. The MPEG-4 AVC/H.264 format is adopted to compress video data, and the Dolby Digital or Linear PCM system is used to compress audio data.

The MPEG-4 AVC/H.264 format is capable of compressing images at higher efficiency than that of the conventional image compressing format.

- As the AVCHD format uses a compression coding technology, the picture may be disturbed in scenes where picture, field angles or brightness, etc. change drastically, but this is not a malfunction.

Recording and playback on your camcorder

Based on the AVCHD format, your camcorder records with the high definition image quality (HD).

In addition to high definition image quality (HD), your camcorder is capable of recording a standard definition (STD) signal in the conventional MPEG-2 format.

Video signal*: MPEG-4 AVC/H.264 1920 × 1080/50p, 1920 × 1080/50i, 1440 × 1080/50i, 1920 × 1080/25p

Audio signal: Dolby Digital 2ch/5.1ch

Recording media: Memory card

- * Data recorded in AVCHD format other than the above mentioned cannot be played on your camcorder.

About the memory card

- A memory card formatted by a computer (Windows OS/Mac OS) does not have guaranteed compatibility with your camcorder.
- Data read/write speed may vary depending on the combination of the memory card and memory card compliant product you use.
- Damaged or lost data may occur in the following cases (the data will not be compensated for):
 - If you eject the memory card, or turn off your camcorder while your camcorder is reading or writing image files on the memory card (while the access lamp is lit or flashing)
 - If you use the memory card near magnets or magnetic fields
- It is recommended that you make a back-up of important data on the hard disk of a computer.
- Do not attach a label or the like on memory card or memory card adaptor.
- Do not touch, or allow metallic objects to come into contact with the terminals.
- Do not bend, drop or apply strong force to the memory card.
- Do not disassemble or modify the memory card.
- Do not let the memory card get wet.
- Keep the memory card out of the reach of small children. There is danger that a child might swallow it.
- Do not insert anything other than the compliant size of memory card into the memory card slot. Doing so may cause a malfunction.
- Do not use or keep the memory card in the following locations:
 - Places subject to extremely high temperature, such as a car parked outside in the summer
 - Places under direct sunlight
 - Places with extremely high humidity or subject to corrosive gases

On the memory card adaptor

- When using memory card with memory card compliant device inserting memory card into memory card adaptor, make sure the memory card is inserted facing in the correct direction. Note that improper use may cause a malfunction.

On image data compatibility

- Image data files recorded on memory card by your camcorder conform to the “Design rule for Camera File system” universal standard established by the JEITA (Japan Electronics and Information Technology Industries Association).
- On your camcorder, you cannot play back photos recorded on other devices (DCR-TRV900E or DSC-D700/D770) that do not conform to the universal standard. (These models are not sold in some regions.)
- If you cannot use memory cards that have been used with another device, format it with your camcorder (p. 82). Note that formatting erases all information on the memory card.
- You may not be able to play back images with your camcorder:
 - When playing back image data modified on your computer
 - When playing back image data recorded with other devices

About the “Memory Stick” media

Types of “Memory Stick” media	Recording/Playback
“Memory Stick Duo” media (with MagicGate)	—
“Memory Stick PRO Duo” media (Mark2)	✓
“Memory Stick PRO-HG Duo” media	✓

- This product supports parallel data transfer. However, the transfer speed may differ, depending on the type of media you use.
- This product cannot record or play data that uses “MagicGate” technology. “MagicGate” is a copyright protection technology that records and transfers the contents in an encrypted format.

About the “InfoLITHIUM” battery pack

Your camcorder operates only with an “InfoLITHIUM” V series battery packs. “InfoLITHIUM” V series battery packs have the  mark.

What is an “InfoLITHIUM” battery pack?

- An “InfoLITHIUM” battery pack is a lithium-ion battery pack that has functions for communicating information related to operating conditions between your camcorder and an AC Adaptor/charger (sold separately).
- The “InfoLITHIUM” battery pack calculates the power consumption according to the operating conditions of your camcorder, and displays the remaining battery time in charge as a percentage.
- The battery pack NP-FV70/FV100 is compatible with “ActiFORCE.”
“ActiFORCE” is a new generation power system. Battery capacity, boost charge, and the speed and accuracy of battery time remaining calculations have been improved when compared with current “InfoLITHIUM” P-series battery.

To charge the battery pack

- Be sure to charge the battery pack before you start using your camcorder.
- We recommend charging the battery pack in an ambient temperature of between 10 °C to 30 °C (50 °F to 86 °F) until the CHG (charge) lamp turns off. If you charge the battery pack outside of this temperature range, you may not be able to charge it efficiently.

To use the battery pack effectively

- Battery pack performance decreases when the ambient temperature is 10 °C (50 °F) or below, and the length of time you can use the battery pack becomes shorter. In that case, do one of the following to use the battery pack for a longer time.
 - Put the battery pack in a pocket to warm it up, and install it on your camcorder right before you start taking shots.
 - Use a large capacity battery pack: NP-FV100 (sold separately).

- Be sure to close the LCD screen when not recording or playing back on your camcorder. The battery pack is also consumed when your camcorder is in recording standby or playback pause.
- Have spare battery packs ready for 2 or 3 times the expected recording time, and make trial recordings before making the actual recording.
- Do not expose the battery pack to water. The battery pack is not water resistant.

About the remaining battery time indicator

- When the power goes off even though the remaining battery time indicator indicates that the battery pack has enough power to operate, charge the battery pack fully again. Remaining battery time will be indicated correctly. Note, however, that the battery indication will not be restored if it is used in high temperatures for a long time, or if left in a fully charged state, or when the battery pack is frequently used. Use the remaining battery time indication as a rough guide only.
- The  mark that indicates low battery may flash, even if there is still 20 percent of battery charge remaining, depending on the operating conditions or ambient temperature.

About storage of the battery pack

- If the battery pack is not used for a long time, fully charge the battery pack and use it up on your camcorder once a year to maintain proper function. To store the battery pack, remove it from your camcorder and put it in a dry, cool place.
- To discharge the battery pack on your camcorder completely, touch **MENU** (MENU) → [Setup] →  General Settings] → [A. Shut Off] → [Off], and leave your camcorder in recording standby until the power goes off (p. 86).

About battery life

- Battery capacity decreases over time and through repeated use. If decreased usage time between charges becomes significant, it is probably time to replace it with a new one.
- Each battery's life is governed by storage, operating and environmental conditions.

On use and care

- Do not use or store the camcorder and accessories in the following locations:
 - Anywhere extremely hot, cold or humid. Never leave them exposed to temperatures above 60 °C (140 °F), such as under direct sunlight, near heaters or in a car parked in the sun. They may malfunction or become deformed.
 - Near strong magnetic fields or mechanical vibration. The camcorder may malfunction.
 - Near strong radio waves or radiation. The camcorder may not be able to record properly.
 - Near AM receivers and video equipment. Noise may occur.
 - On a sandy beach or anywhere dusty. If sand or dust gets in your camcorder, it may malfunction. Sometimes this malfunction cannot be repaired.
 - Near windows or outdoors, where the LCD screen, the viewfinder or the lens may be exposed to direct sunlight. This damages the inside of the viewfinder or LCD screen.
- Operate your camcorder on DC 6.8 V/7.2 V (battery pack) or DC 8.4 V (AC Adaptor).
- For DC or AC operation, use the accessories recommended in these operating instructions.
- Do not let your camcorder get wet, for example, from rain or sea water. If your camcorder gets wet, it may malfunction. Sometimes this malfunction cannot be repaired.
- If any solid object or liquid gets inside the casing, unplug your camcorder and have it checked by a Sony dealer before operating it any further.
- Avoid rough handling, disassembling, modifying, physical shock, or impact such as hammering, dropping or stepping on the product. Be particularly careful of the lens.
- Keep the LCD screen closed when you are not using your camcorder.
- Do not wrap your camcorder with a towel, for example, and operate it. Doing so might cause heat to build up inside.
- When disconnecting the power cord (mains lead), pull it by the plug and not the cord.
- Do not damage the power cord (mains lead) such as by placing anything heavy on it.

- Do not use a deformed or damaged battery pack.
- Keep metal contacts clean.
- If the battery electrolytic liquid has leaked:
 - Consult your local authorized Sony service facility.
 - Wash off any liquid that may have contacted your skin.
 - If any liquid gets in your eyes, wash with plenty of water and consult a doctor.

When not using your camcorder for a long time

- Be sure to attach the lens front cap when not using the camcorder.
- To keep your camcorder in optimum state for a long time, turn it on and let it run by recording and playing back images about once a month.
- Use up the battery pack completely before storing it.

Operating temperature.

- This camcorder is designed for use in a temperature range of between 0 °C and 40 °C (32 °F to 104 °F). Shooting in extremely cold or hot places that exceed this range is not recommended.

Moisture condensation

If your camcorder is brought directly from a cold place to a warm place, moisture may condense inside your camcorder. This may cause a malfunction to your camcorder.

- If moisture condensation has occurred
Leave your camcorder for about 1 hour without turning it on.
- Note on moisture condensation
Moisture may condense when you bring your camcorder from a cold place into a warm place (or vice versa) or when you use your camcorder in a humid place as follows:
 - You bring your camcorder from a ski slope into a place warmed up by a heating device.
 - You bring your camcorder from an air conditioned car or room into a hot place outside.
 - You use your camcorder after a squall or a shower.
 - You use your camcorder in a hot and humid place.

- How to prevent moisture condensation
When you bring your camcorder from a cold place into a warm place, put your camcorder in a plastic bag and seal it tightly. Remove the bag when the air temperature inside the plastic bag has reached the surrounding temperature (after about 1 hour).

LCD screen

- Do not exert excessive pressure on the LCD screen, as it may cause uneven color and other damage.
- If your camcorder is used in a cold place, a residual image may appear on the LCD screen. This is not a malfunction.
- While using your camcorder, the back of the LCD screen may heat up. This is not a malfunction.

To clean the LCD screen

- If fingerprints or dust make the LCD screen dirty, it is recommended that you use a soft cloth to clean it.

On adjustment of the touch panel ([Calibration])

The buttons on the touch panel may not work correctly. If this happens, follow the procedure below. It is recommended that you connect your camcorder to the wall outlet (wall socket) using the supplied AC Adaptor during the operation.

- ① **MENU** (MENU) → [Setup] →
[(General Settings)] → [Calibration].

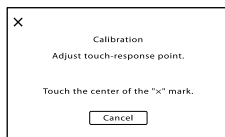

- ② Touch "x" displayed on the screen with the corner of memory card or the like 3 times.
Touch [Cancel] to cancel calibration.

Notes

- If you did not press the right spot, try the calibration again.
- Do not use a sharp-pointed object for calibration. Doing so may damage the LCD screen.
- You cannot calibrate the LCD screen if it is rotated, or closed with the screen facing out.

On handling the casing

- If the casing is soiled, clean the camcorder body with a soft cloth lightly moistened with water, and then wipe the casing with a dry soft cloth.
- Avoid the following to avoid damage to the finish:
 - Using chemicals such as thinner, benzene, alcohol, chemical cloths, repellent, insecticide and sunscreen
 - Handling the camcorder with above substances on your hands
 - Leaving the casing in contact with rubber or vinyl objects for a long period of time

About care and storage of the lens

- Wipe the surface of the lens clean with a soft cloth in the following instances:
 - When there are fingerprints on the lens surface
 - In hot or humid locations
 - When the lens is exposed to salty air such as at the seaside
- Store in a well-ventilated location subject to little dirt or dust.
- To prevent mold, periodically clean the lens as described above.

On charging the pre-installed rechargeable battery

Your camcorder has a pre-installed rechargeable battery to retain the date, time, and other settings even when the LCD screen is closed. The pre-installed rechargeable battery is always charged while your camcorder is connected to the wall outlet (wall socket) via the AC Adaptor or while the battery pack is attached. The rechargeable battery will be fully discharged in about 3 months if you do not use your camcorder at all. Use your camcorder after charging the pre-installed rechargeable battery.

However, even if the pre-installed rechargeable battery is not charged, the camcorder operation will not be affected as long as you are not recording the date.



How to charge the pre-installed rechargeable battery

Connect your camcorder to a wall outlet (wall socket) using the supplied AC Adaptor, and leave it for more than 24 hours.

Note on disposal/transfer of the memory card

Even if you delete data in the memory card or format the memory card on your camcorder or a computer, you may not delete data from the memory card completely. When you give the memory card to somebody, it is recommended that you delete data completely using data deletion software on a computer. Also, when you dispose of the memory card, it is recommended that you destroy the actual body of the memory card.

On trademarks

- “Handycam” and **HANDYCAM** are registered trademarks of Sony Corporation.
- “AVCHD Progressive” and “AVCHD Progressive” logotype are trademarks of Panasonic Corporation and Sony Corporation.
- “Memory Stick,” “,” “Memory Stick Duo,” “**MEMORY STICK DUO**,” “Memory Stick PRO Duo,” “**MEMORY STICK PRO DUO**,” “Memory Stick PRO-HG Duo,” “**MEMORY STICK PRO-HG DUO**,” “MagicGate,” “**MAGICGATE**,” “MagicGate Memory Stick” and “MagicGate Memory Stick Duo” are trademarks or registered trademarks of Sony Corporation.
- “InfoLITHIUM” is a trademark of Sony Corporation.
- “BRAVIA” is a trademark of Sony Corporation.
- “DVDirect” is a trademark of Sony Corporation.
- Blu-ray Disc™ and Blu-ray™ are trademarks of the Blu-ray Disc Association.
- Dolby and the double-D symbol are trademarks of Dolby Laboratories.
- HDMI, the HDMI logo and High-Definition Multimedia Interface are trademarks or registered trademarks of HDMI Licensing LLC in the United States and other countries.
- Microsoft, Windows, Windows Vista, and DirectX are either registered trademarks or trademarks of Microsoft Corporation in the United States and/or other countries.
- Macintosh and Mac OS are registered trademarks of Apple Inc. in the U.S. and other countries.
- Intel, Intel Core, and Pentium are trademarks or registered trademarks of Intel Corporation or its subsidiaries in the United States and other countries.
- “” and “PlayStation” are registered trademarks of Sony Computer Entertainment Inc..
- Adobe, the Adobe logo, and Adobe Acrobat are either registered trademarks or trademarks of Adobe Systems Incorporated in the United States and/or other countries.
- SDXC logo is a trademark of SD-3C, LLC.
- MultiMediaCard is a trademark of MultiMediaCard Association.

All other product names mentioned herein may be the trademarks or registered trademarks of their respective companies. Furthermore, ™ and ® are not mentioned in each case in this Handbook.

Notes on the License

ANY USE OF THIS PRODUCT OTHER THAN CONSUMER PERSONAL USE IN ANY MANNER THAT COMPLIES WITH THE MPEG-2 STANDARD FOR ENCODING VIDEO INFORMATION FOR PACKAGED MEDIA IS EXPRESSLY PROHIBITED WITHOUT A LICENSE UNDER APPLICABLE PATENTS IN THE MPEG-2 PATENT PORTFOLIO, WHICH LICENSE IS AVAILABLE FROM MPEG LA, L.L.C., 250 STEELE STREET, SUITE 300, DENVER, COLORADO 80206.

THIS PRODUCT IS LICENSED UNDER THE AVC PATENT PORTFOLIO LICENSE FOR THE PERSONAL AND NON-COMMERCIAL USE OF A CONSUMER TO

- (i) ENCODE VIDEO IN COMPLIANCE WITH THE AVC STANDARD (“AVC VIDEO”) AND/OR
- (ii) DECODE AVC VIDEO THAT WAS ENCODED BY A CONSUMER ENGAGED IN A PERSONAL AND NON-COMMERCIAL ACTIVITY AND/OR WAS OBTAINED FROM A VIDEO PROVIDER LICENSED TO PROVIDE AVC VIDEO. NO LICENSE IS GRANTED OR SHALL BE IMPLIED FOR ANY OTHER USE. ADDITIONAL INFORMATION MAY BE OBTAINED FROM MPEG LA, L.L.C. SEE <[HTTP://WWW.MPEGLA.COM](http://www.mpegla.com)>

“C Library,” “zlib,” and “libjpeg” software are provided in your camcorder. We provide this software based on license agreements with their owners of copyright. Based on requests by the owners of copyright of these software applications, we have an obligation to inform you of the following. Please read the following sections.

Read “license3.pdf” in the “License” folder on the CD-ROM. You will find licenses (in English) of “C Library,” “zlib,” and “libjpeg” software.

On GNU GPL/LGPL applied software

The software that is eligible for the following GNU General Public License (hereinafter referred to as “GPL”) or GNU Lesser General Public License (hereinafter referred to as “LGPL”) are included in the camcorder.

This informs you that you have a right to have access to, modify, and redistribute source code for these software programs under the conditions of the supplied GPL/LGPL.

Source code is provided on the web. Use the following URL to download it. When downloading the source code, select NEX-VG20 as the model for your camcorder.

<http://www.sony.net/Products/Linux/>

We would prefer you do not contact us about the contents of source code.

Read "license2.pdf" in the "License" folder on the CD-ROM. You will find licenses (in English) of "GPL," and "LGPL" software.

To view the PDF, Adobe Reader is needed. If it is not installed on your computer, you can download it from the Adobe Systems web page:

<http://www.adobe.com/>

Screen indicators

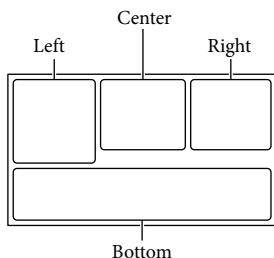

Left

Indicator	Meaning
	MENU button (67)
	Self-timer recording (75)
	Wide Mode (81)
	[Face Detection] set to [Off] (76)
	Manual focus (41)
	Focus Mode (75)
	White Balance (72)
	SteadyShot off (76)
	White Balance Shift (75)
	Zebra (78)
	Peaking (78)
	Cinematone (75)
	Destination (87)

Center













Indicator	Meaning
	Recording status (31)
	Slide show set
	Warning (94)
	Playback mode (36)

Right

Indicator	Meaning
	Recording image quality (HD/STD), frame rate (50p/50i/25p) and recording mode (PS/FX/FH/HQ/LP) (43)
	Remaining battery
	Zoom-bar
	Drive Mode (75)
	RAW/JPEG (81)
	Recording/playback/editing media (28)
	Counter (hour:minute:second)
	Estimated recording remaining time
	Photo size (81)
	Approximate number of recordable photos and photo size
	Playback folder
	Current playing movie or photo/Number of total recorded movies or photos (36)
	An external media device is connected (61)

Bottom

Indicator	Meaning
	View Images button (34)
	Wind Noise Reduct. (77)
	Audio Mode (78)
	Audio Rec Level (78)
	Audio Level Display (79)
	AE Shift (74)
	Exposure Auto (48)/Exposure Manual (49)

Indicator	Meaning
F1.4	IRIS (46)
12 dB	 Gain (74)
ISO 200	 ISO (74)
4000	Shutter Speed (47)
	Slide show button
 101-0005	Data file name (37)
	Protected image (51)
  HSS  HSS	Flash (77)
 SL  REAR	
	Flash Level (77)
	Red Eye Reduction (77)

- Indicators and their positions are approximate and may differ from what you actually see.
- Some indicators may not appear, depending on your camcorder model.

Parts and controls

The illustrations attached the lens (E 18-200mm F3.5-6.3 OSS) supplied with NEX-VG20EH are described here.

Figures in () are reference pages.

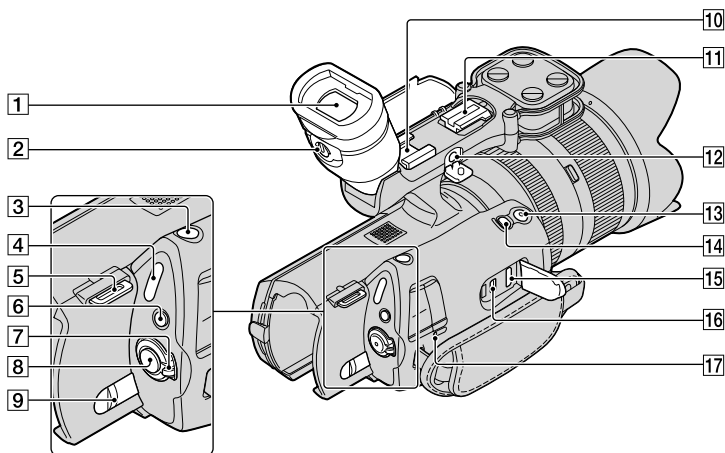

- 1** Viewfinder (26)
- 2** Viewfinder lens adjustment lever (26)
- 3** PHOTO button (32)
- 4** (Movie)/ (Photo) lamps (31)
- 5** Hook for shoulder strap
- 6** MODE button (31)
- 7** ON/OFF (power) switch (23)
- 8** START/STOP button (31)
- 9** BATT (battery) release lever (16)
- 10** Accessory shoe
Attach a gun microphone (sold separately), etc. If you attach accessories to the accessory shoe and auto lock accessory shoe simultaneously, the accessories may collide with each other and be damaged.
- 11** Auto lock accessory shoe
Attach a Sony external flash (sold separately), etc.
The flash does not work when [Drive Mode] is set to [Bracket: 0.3 EV] or [Bracket:

0.7 EV]. There are certain Sony flashes or functions that cannot be used with your camcorder. For the compatibility of a particular flash unit, visit the Sony web site in your area, or consult your Sony dealer or local authorized Sony service facility.

- 12** MIC (PLUG IN POWER) jack
When an external microphone (sold separately) is connected, it takes precedence over the built-in microphone.
- 13** START/STOP button on the grip (45)
Use this button when recording at a different angle.
- 14** EXPANDED FOCUS button (42)
The EXPANDED FOCUS button has a tactile dot. Use as a guide for the operation.
- 15** HDMI OUT jack (38)
- 16** (USB) jack (61)
- 17** CHG (charge) lamp (15)

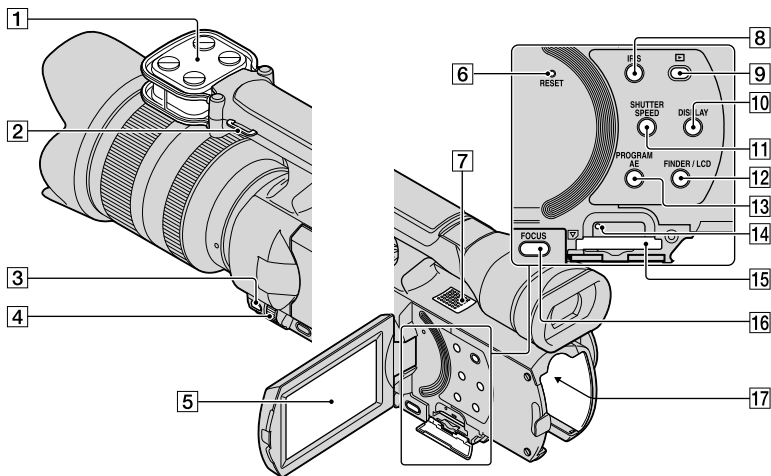

1 Microphone (44)

2 Hook for shoulder strap

3 MANUAL button (46)

4 MANUAL dial (46)

5 LCD screen/Touch panel (23, 45)

If you rotate the LCD panel 180 degrees, you can close the LCD panel with the LCD screen facing out. This is convenient during playback operations.

6 RESET button

Press RESET using a pointed object.

Press RESET to initialize all the settings including the clock setting.

7 Speaker

8 IRIS button (46)

9  (View Images) button (34)

10 DISPLAY button (25)

11 SHUTTER SPEED button (47)

12 FINDER/LCD button (25)

13 PROGRAM AE button (46)

14 Memory card access lamp (28)

While the lamp is lit or flashing, the camcorder is reading or writing data.

15 Memory card slot (28)

16 FOCUS button (41)

17 Battery terminal (15)

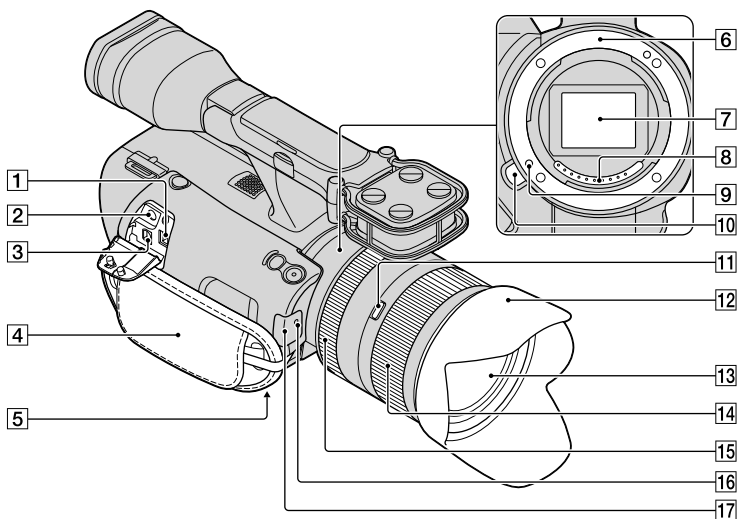

1 DC IN jack (15)

2  (headphones) jack

Use stereo minijack headphones.

3 A/V Remote Connector (38)

This terminal is to interface your camcorder to another device. You can output still images, movies and sound to a connected TV, or control your camcorder when it is mounted on a remote control video tripod.

4 Grip belt (30)

5 Tripod receptacle

Attach a tripod (sold separately) to the tripod receptacle using a tripod screw (sold separately: the length of the screw must be less than 5.5 mm (7/32 in.)).

6 Mount (18)

7 Image sensor

Do not touch or dirty the image sensor.

8 Lens contacts

Do not touch or dirty the lens contacts.

9 Lens lock pin

10 Lens release button (20)

11 Zoom lock switch (18)

12 Lens hood (13)

13 Lens (18)

14 Zoom ring (41)

15 Focusing ring (18)

16 Camera recording lamp

Point the Wireless Remote Commander (p. 113) towards the remote sensor to operate your camcorder.

Remove the lens hood when you operate the camcorder with the supplied remote commander.

17 Remote sensor (86)

Wireless Remote Commander

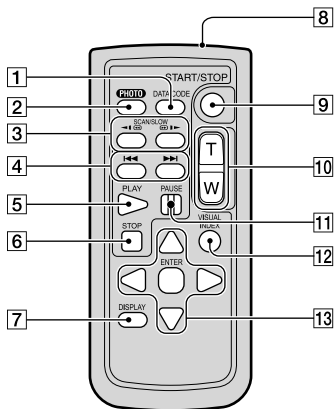

1 DATA CODE button (83)

Displays the date and time or camera setting data of the recorded images when you press this button during playback.

2 PHOTO button (32)

The on-screen image when you press this button will be recorded as a still image.

Note

- [Single Shooting] is always set regardless [Drive Mode] setting when using the PHOTO button on the Wireless Remote Commander for shooting. Note that shooting may not be possible if it is difficult to focus on a subject.

3 SCAN/SLOW buttons (36)

4 ◀/▶ (Previous/Next) buttons (36)

5 PLAY button

6 STOP button

7 DISPLAY button (25)

8 Transmitter

9 START/STOP button (31)

10 Power zoom buttons

You cannot use this button with this camcorder.

11 PAUSE button

12 VISUAL INDEX button (34)

Displays an Event Index screen during playback.

13 ◀/▶/▲/▼/ENTER buttons

When you press any of these buttons, the orange frame appears on the LCD screen. Select a desired button or an item with ◀/▶/▲/▼, then press ENTER to enter.

Notes

- Remove the insulation sheet before using the Wireless Remote Commander.

Insulation sheet

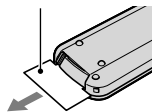

- Point the Wireless Remote Commander towards the remote sensor to operate your camcorder (p. 112).
- When no commands have been sent from the Wireless Remote Commander within a certain period, the light blue frame disappears. When you press any of ◀/▶/▲/▼, or ENTER again, the frame appears at the position where it was displayed last.
- You cannot select some buttons on the LCD screen using ◀/▶/▲/▼.

To change the battery of the Wireless Remote Commander

- ① While pressing on the tab, inset your fingernail into the slit to pull out the battery case.
- ② Place a new battery with the + side facing up.
- ③ Insert the battery case back into the Wireless Remote Commander until it clicks.

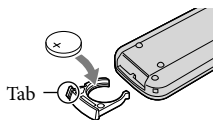

WARNING

Battery may explode if mistreated. Do not recharge, disassemble or dispose of in fire.

- When the lithium battery becomes weak, the operating distance of the Wireless Remote Commander may shorten, or the Wireless Remote Commander may not function properly. In this case, replace the battery with a Sony CR2025 lithium battery. Use of another battery may present a risk of fire or explosion.

Index

Symbols

1080i/576i.....	84
1080p/576p.....	84
5.1ch surround recording.....	44
576i.....	84

A

A. Shut Off.....	86
A/V connecting cable.....	39, 65
Abroad.....	99
AE Shift.....	74
AF Micro Adjustment.....	80
AF Mode.....	75
Area Setting.....	87
Audio Level Display.....	79
Audio Mode.....	78
Audio Rec Level.....	78
Auto Back Light.....	76
AVCHD.....	53
AVCHD format.....	101

B

Battery Info.....	87
Battery of the Wireless Remote Commander.....	114
Battery pack.....	15
Beep.....	85
Blu-ray disc.....	58
“BRAVIA” Sync.....	40

C

Calibration.....	104
Camera/Mic.....	72
Camera Data.....	83
Camera Data Display.....	79
Capturing photos from a movie	52
Charging the battery pack.....	15
Charging the battery pack abroad	16, 99
Cinematone.....	75
Clock Set.....	23
Component.....	84
Component Output.....	84
Connection.....	38

Copy.....	50
Copying a disc.....	58
Creating a disc.....	53
Creating AVCHD disc.....	57
CTRL FOR HDMI.....	84

D

Data Code.....	24, 83
Date/Time.....	24
Date & Time Setting.....	87
Delete.....	50
Disc Burn.....	55
Disc recorder.....	65
Display Setting.....	86
Divide.....	51
Drive Mode.....	75
DVD writer.....	64

E

Edit/Copy.....	82
Event Index.....	34
Exposure.....	73
External media.....	61

F

Face Detection.....	76
FH.....	43
File Number.....	83
Flash.....	77
Flash Level.....	77
Format.....	82
Frame Rate.....	80
Fully charged.....	15
FX.....	43

G

Gain.....	74
Guide Frame.....	78

H

HD/STD Set.....	42
HDMI Resolution.....	84
Histogram.....	79
HQ.....	43

I

Image quality.....	42
Image Quality/Size.....	80
Image Size.....	81
Indoor.....	72
“InfoLITHIUM” battery pack	102
IRIS.....	46
ISO.....	74

L

Language Setting.....	24, 86
LCD Brightness.....	85
Lens.....	18
LP.....	43

M

Maintenance.....	101
MANUAL Button.....	76
MANUAL dial.....	46
Media Info.....	82
Media Settings.....	28
“Memory Stick” media.....	29, 101
“Memory Stick PRO-HG Duo” media.....	29
“Memory Stick PRO Duo” media	29
Menus.....	68
Mirror mode.....	45
Moisture condensation.....	104
Movies.....	31, 36
MPEG-4 AVC/H.264.....	101

O

One Push.....	72
Outdoor.....	72

P

PAL.....	99
Peaking.....	78
Photo Capture.....	52
Photos.....	32, 37
Playing.....	34
Playing AVCHD disc.....	57
PMB Help.....	2
Power on.....	23

Precautions.....	101
PROGRAM AE.....	46
Protect.....	51
PS.....	43

R

RAW/JPEG.....	81
REC Lamp.....	86
Rec Mode.....	43
Recording.....	30
Recording and playback time ..	97
Recording media.....	28
Recording time of movies/ number of recordable photos....	97
Red Eye Reduction.....	77
Remote Ctrl.....	86, 113
Repair Img.DB F.....	92
RESET.....	111

S

Saving images in external media	61
Screen indicators.....	108
Self-diagnosis display/Warning indicators.....	94
Self-Timer.....	75
Setting the date and time.....	23
Setup.....	82
Shooting Mode.....	72
Shooting w/o Lens.....	86
SHUTTER SPEED.....	46
Spot Focus.....	73
Spot Meter.....	73
Spot Meter/Fcs.....	73
SteadyShot (Movie).....	76
SteadyShot (Photo).....	76
SummerTime.....	87

T

Tripod.....	112
Troubleshooting.....	88
Turning the power on.....	23
TV.....	38
TV color systems.....	99
TV Type.....	83

U

USB cable.....	64
USB Connect.....	56
USB Connect Setting.....	85

V

VBR.....	97
Version.....	87
VF Brightness.....	85
Volume.....	83

W

Wall outlet (wall socket).....	15
Warning messages.....	95
White Balance.....	72
White Balance Shift.....	75
Wide Mode.....	81
Wind Noise Reduct.....	77

Z

Zebra.....	78
Zoom.....	41

Additional information on this product and answers to frequently asked questions can be found at our Customer Support Website.

<http://www.sony.net/>