

ProHeat 2X[®]

USER'S GUIDE

8920, 8930, 8960, 9200, 9300, 9400 SERIES



3 Safety Instructions

4-5 Product View

6 Assembly

7-8 Special Features

9-15 Operation

16-18 Maintenance and Care

19-20 Troubleshooting

21 Consumer Services

22-23 Replacement Parts

24 Warranty



Thanks for buying a BISSELL ProHeat 2X

We're glad you purchased a BISSELL ProHeat 2X heated formula deep cleaner. Everything we know about floor care went into the design and construction of this complete, high-tech home cleaning system.

Your ProHeat 2X is well made, and we back it with a limited one-year warranty. We also stand behind it with a knowledgeable, dedicated Consumer Services department, so, should you ever have a problem, you'll receive fast, considerate assistance.

My great-grandfather invented the floor sweeper in 1876. Today, BISSELL is a global leader in the design, manufacture, and service of high quality homecare products like your ProHeat 2X.

Thanks again, from all of us at BISSELL.

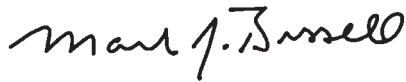

Mark J. Bissell
President and Chief Executive Officer

IMPORTANT SAFETY INSTRUCTIONS

When using an electrical appliance, basic precautions should be observed, including the following:

Read all instructions before using your ProHeat 2X®

⚠ WARNING: To reduce the risk of fire, electric shock, or injury:

- Do not immerse.
- Use only on surfaces moistened by cleaning process.
- Always connect to a properly grounded outlet.
- See Grounding Instructions.
- Unplug from outlet when not in use and before conducting maintenance or troubleshooting.
- Do not leave machine when it is plugged in.
- Do not service machine when it is plugged in.
- Do not use with damaged cord or plug.
- If appliance is not working as it should, has been dropped, damaged, left outdoors, or dropped into water, have it repaired at an authorized Service Center.
- Use indoors only.
- Do not pull or carry by cord, use cord as a handle, close door on cord, pull cord around sharp corners or edges, run appliance over cord, or expose cord to heated surfaces.
- Unplug by grasping the plug, not the cord.
- Do not handle plug or appliance with wet hands.
- Do not put any object into appliance openings, use with blocked opening, or restrict air flow.
- Do not expose hair, loose clothing, fingers or body parts to openings or moving parts.
- Do not pick up hot or burning objects.
- Do not pick up flammable or combustible materials (lighter fluid, gasoline, kerosene, etc.) or use in the presence of explosive liquids or vapor.
- Do not use appliance in an enclosed space filled with vapors given off by oil base paint, paint thinner, some moth proofing substances, flammable dust, or other explosive or toxic vapors.
- Do not pick up toxic material (chlorine bleach, ammonia, drain cleaner, gasoline, etc.).
- Do not modify the 3-prong grounded plug.
- Do not allow to be used as a toy.
- Do not use for any purpose other than described in this User's Guide.
- Do not operate the appliance unless the belt door is securely assembled in the location provided.
- Do not unplug by pulling on the cord.
- Use only manufacturer's recommended attachments.
- Always install float before any wet pick up operation.
- Use only cleaning products formulated by BISSELL for use in this appliance to prevent internal component damage. See the cleaning fluid section of this guide.
- Keep openings free of dust, lint, hair, etc.
- Do not point attachment nozzle at people or animals
- Keep appliance on a level surface.

- Turn off all controls before unplugging.
- Unplug before attaching the TurboBrush.®
- Be extra careful when cleaning stairs.
- Close attention is necessary when used by or near children.
- **WARNING:** The power cord on this product contains lead, a chemical known to the State of California to cause birth defects or other reproductive harm.
WASH HANDS AFTER HANDLING.

SAVE THESE INSTRUCTIONS.

THIS MODEL IS FOR HOUSEHOLD USE ONLY.
Commercial use of this unit voids the manufacturer's warranty.

GROUNDING INSTRUCTIONS

This appliance must be connected to a grounded wiring system. If it should malfunction or break down, grounding provides a safe path of least resistance for electrical current, reducing the risk of electrical shock. The cord for this appliance has an equipment-grounding conductor and a grounding plug. It must only be plugged into an outlet that is properly installed and grounded in accordance with all local codes and ordinances.

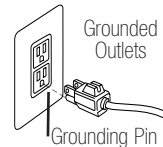

⚠ WARNING: Improper connection of the equipment-grounding conductor can result in a risk of electrical shock. Check with a qualified electrician or service person if you aren't sure if the outlet is properly grounded. **DO NOT MODIFY THE PLUG.** If it will not fit the outlet, have a proper outlet installed by a qualified electrician. This appliance is designed for use on a nominal 120-volt circuit, and has a grounding attachment plug that looks like the plug in the drawing above. Make certain that the appliance is connected to an outlet having the same configuration as the plug. No plug adapter should be used with this appliance.

Product view

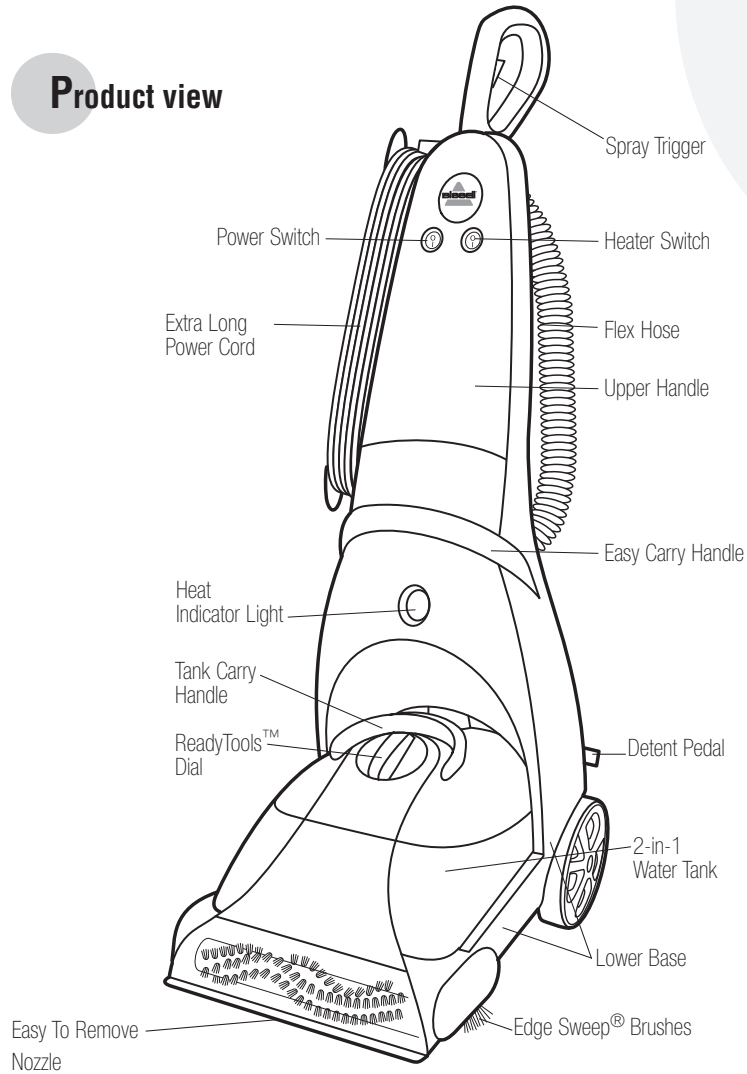

Optional Accessories:

These items are available for purchase. To order replacement parts, additional tools or formulas, please refer to page 22-23.



3" Tough Stain Brush



4" Upholstery Tool

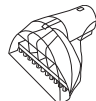

6" Stair Tool

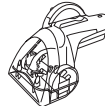

TurboBrush®

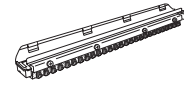

Hard Floor Attachment



Spraying Crevice Tool



Mesh Tool Bag
(bag only)

Product view

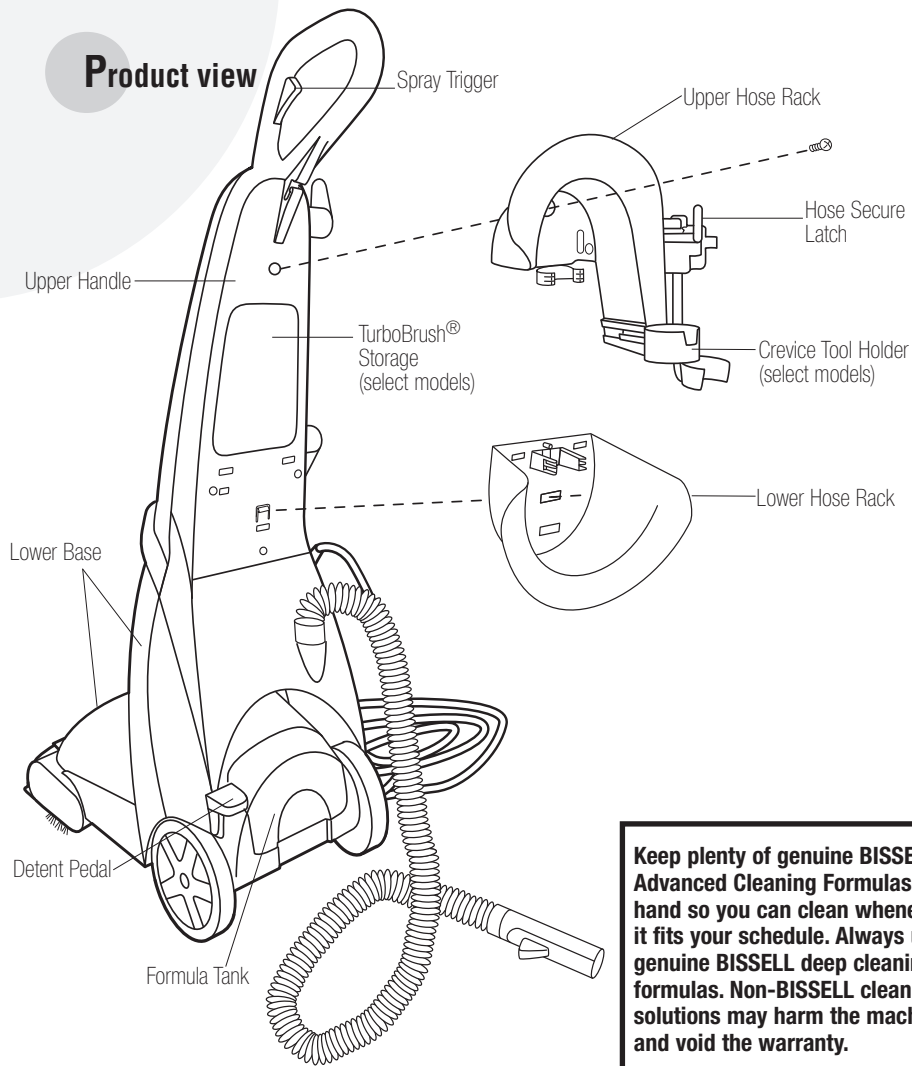

Keep plenty of genuine BISSELL Advanced Cleaning Formulas on hand so you can clean whenever it fits your schedule. Always use genuine BISSELL deep cleaning formulas. Non-BISSELL cleaning solutions may harm the machine and void the warranty.

BISSELL Formulas:

These items are available for purchase. To order replacement parts, additional tools or formulas, please refer to page 22-23.



48 oz. BISSELL
Fiber Cleansing
Formula™ with
Scotchgard™
Protector
#0710

48 oz. BISSELL
Multi- Allergen
Removal™
Formula™ with
Scotchgard™
Protector
#0720

48 oz. BISSELL
Pet Odor and Soil
Removal™ Formula
with Scotchgard™
Protector
#0730

48 oz. BISSELL
Natural Orange
Extract Formula™
with Scotchgard™
Protector
#0740

48 oz. BISSELL
Lavender Essence
Formula with
Scotchgard™
Protector
#0750

43 oz. BISSELL
3X Concentrated
Fiber Cleansing
Formula with
Scotchgard™
Protector
#0716

32 oz.
BISSELL
Hard Floor
Solutions™
Formula
#0484

22 oz.
BISSELL
Tough Stain
PreCleaner™
#0400

www.bissell.com



800.237.7691

5

How to use this guide

This user's guide has been designed to help you get the utmost satisfaction from your BISSELL ProHeat 2X. You'll find assembly and operating instructions, safety precautions, as well as maintenance and troubleshooting instructions. Please read this guide thoroughly before assembling your deep cleaner.

Pay particular attention to the product diagram, assembly instructions, and part names. Locate and organize all parts before assembly. Familiarize yourself with the parts and where they go. Following this user's guide will greatly enhance your ability to get the most performance from your BISSELL ProHeat 2X for many years.

Assembly

Your ProHeat 2X comes in three, easy to assemble components:

- Upper Handle
- Lower Handle
- Tool Caddy

The only thing you will need to assemble your cleaner is a Phillips head  screwdriver.

1. Slide upper handle onto lower handle.
2. Screw 3 screws into the marked holes.
3. Place upper hose rack onto back of upper handle, and secure with tapered screw.
4. Place lower hose rack onto back of upper handle by pushing in and sliding down until it snaps into place.
5. Snap tools into the tool caddy as shown in figure 5.
6. Wrap power cord and flex hose as shown in figure 5.
7. Keep flex hose snugly in place by using the hose secure latch.

ProHeat 2X assembly is now complete.



WARNING:

Do not plug in your cleaner until you have completely assembled it per the following instructions and are familiar with all instructions and operating procedures.

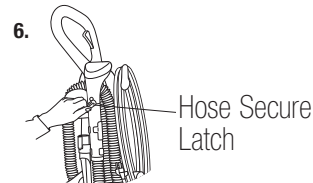
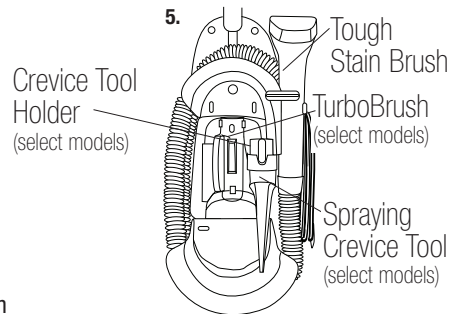
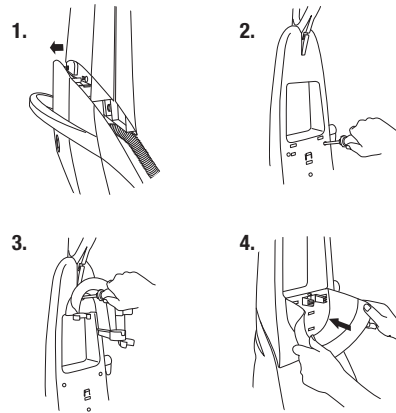

Special features of your BISSELL ProHeat 2X

Your BISSELL ProHeat 2X deep cleaner is a home cleaning system that uses the power of heat, brushes and cleaning formula to get the deep down dirt for a maximum clean. Not only does it come with a lot of unique features, it has been designed with you, the customer, in mind.

Built-in-Heater feature

BISSELL ProHeat 2X models all feature a patented built-in heater which will heat the hot tap water you put in up to 25 degrees hotter to safely optimize cleaning effectiveness. The heater will never allow the temperature to exceed 190 degrees. The heater switch on the front of the machine controls the heater so you have the option to turn off the heat if you are cleaning delicate wool or oriental rugs.

Dual DirtLifter® PowerBrushes

The two DirtLifter PowerBrush rolls are designed to enhance cleaning performance. The bristle pattern safely lifts out the deep down dirt while gently grooming carpet fibers. The floating suspension self-adjusts to all carpet heights and protects your carpet if you leave the power switch ON (I). Once the product is in the upright position, the brushes automatically stop spinning. The detent pedal will activate the brushes when floor cleaning.

Custom Clean®

The Custom Clean feature automatically mixes hot tap water with the BISSELL formula. Simply choose one of the 4 settings (heavy traffic, normal clean, light clean, or water rinse) and the ProHeat 2X will adjust the right amount of cleaning solution to mix with the heated water to fit your cleaning need.

This feature is available on all ProHeat 2X models, either behind the 2-in-1 water tank or on the upper handle.

Having a separate solution tank from the water tank also allows no waste of formula. Because the water and solution are stored separately, they are not mixed until you are ready to clean. When your cleaning job is finished, the formula can be stored ready to use in your machine for the next time!

(located behind water tank)

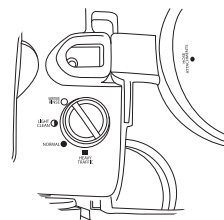

OR

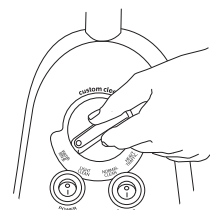

(located on upper handle)

Special features of your BISSELL ProHeat 2X

Scotchgard™ Protector

Carpet protection applied at the mill typically wears down over time from heavy foot traffic and everyday cleaning, including deep cleaning. To help restore this important protection, only BISSELL offers deep cleaning formulas with Scotchgard protector. This offers extra protection against dirt and tough stains to keep your carpets looking good longer.

To maintain your Scotchgard 5-year limited stain warranty, you no longer are required to hire a professional. By using your BISSELL ProHeat machine with BISSELL formulas containing Scotchgard protector every 12 months, your carpet warranty from 3M remains in effect. No other home deep cleaning system can do this for you.



2-in-1 water tank

Our 2-in-1 water tank full capacity system is designed with a heavy duty bladder inside for clean water. As you clean, the clean water in the bladder will empty and mix with the cleaning formula. Dirty water pulled out of your carpets will collect around the outside of the bladder so that clean and dirty water are always kept separate. This allows the user to maximize tank space, yet only carry one tank to and from the sink for emptying and filling.



Easy to remove and clean nozzle

Now, cleaning up your machine after the cleaning process is easier than ever! Simply remove the 2-in-1 Tank and remove the screw to pop out the nozzle for rinsing in the sink. Dirt, loose carpet fibers and remaining pet hair or fuzz get washed away in a snap.

ReadyTools™ dial

This provides either floor cleaning or above floor cleaning with the turn of a knob. If choosing above floor cleaning for upholstery, stairs, or for those creases close to the baseboards, turn knob to "TOOLS" and choose the attachment appropriate for the job. Attach tool to the flex hose and you are ready to go. Be sure to turn knob back to "FLOOR CLEANING" when done.

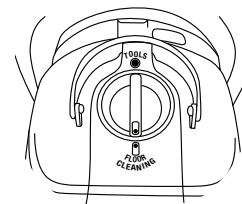

Operation

Before you clean

1. Plan activities to give your carpet time to dry.
2. **Move furniture** to another area if cleaning an entire room (optional).
3. **Vacuum area** with a dry vacuum cleaner thoroughly before deep cleaning.
4. Plan your cleaning route to leave an exit path. It is best to begin cleaning in the corner farthest from your exit.
5. **Pretreating** (optional)
Pretreating is recommended to improve cleaning effectiveness for heavily soiled carpet in high traffic areas such as entryways and hallways.
 - A. Spray the BISSELL Tough Stain Pre-treat formula onto heavy traffic areas, soiled areas, or stains.
 - B. Allow to penetrate for at least 3 minutes.
 - C. Clean as normal, using the BISSELL ProHeat 2X machine on the high traffic setting, following the instructions below.

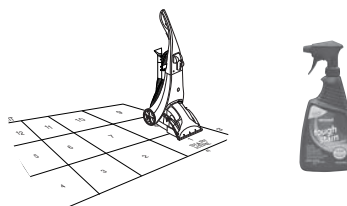

ATTENTION:

Some Berber carpets have a tendency to fuzz with wear. Repeated strokes in the same area with an ordinary vacuum or deep cleaner may aggravate this condition. Please see Stain Removal instructions on page 14.

Carpet cleaning

1. **Fill the 2-in-1 Water Tank.** Remove the tank from the base of the machine by lifting up the tank carry handle. Carry like a bucket to the sink.
 - 1a. Unlatch the top of the tank from the bottom by lifting up on the tank latch which is located on the back of the tank.
 - 1b. Remove the top of the tank by lifting up on the handle.
Note how the lip on the top tank separates from the groove in the bottom tank. This placement is important when putting the tank back together.
 - 1c. Fill the heavy duty bladder with clean hot tap water.
***Do not boil or microwave water as it can destroy the bladder.**
 - 1d. Leaving the filled bottom of the tank on a flat surface, only maneuver the top of the tank. To attach the top part of the tank to the bottom, carefully hook the lip on the top tank into the groove on the bottom tank.

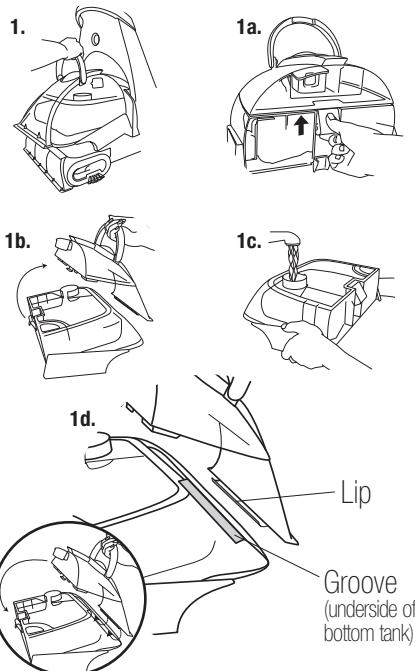

Operation

Carpet cleaning (Continued)

- 1e. Fasten tanks together by securing the latch in the back.

Note: Remember to secure the tank latch in the back and test to make sure it is secure before picking up the tank.

2. Remove formula tank from back of machine.

- 2a. Fill the formula tank by first unscrewing the cap and insert. Always use genuine BISSELL formulas to maximize cleaning and for the safety of your machine. Fill formula up to the line and replace the cap and insert. Place formula tank into the slot in the back of the machine for a snug fit.

- 2b. If using the BISSELL 3X Concentrated Fiber Cleansing Formula: Add 3 capfuls of 3X Concentrated Fiber Cleansing formula to the formula tank, and then fill with hot water to the line.

3. Set Custom Clean Dial. Simply choose one of the 4 settings (heavy traffic, normal clean, light clean, or water rinse) and the ProHeat 2X will adjust the right amount of cleaning solution to mix with the heated water to fit your cleaning need.

4. Set ReadyTools Dial to the floor cleaning setting.

5. Plug into a proper outlet and turn the power and heater switches to the ON (I) position. Allow 1 minute for the built-in heater to warm-up before cleaning. The ProHeat 2X will be fully warmed and will provide optimal performance after a minute of continuous heated cleaning.

6. Cleaning Strokes. While pressing the trigger, make one slow forward wet pass and another one back. Let the built-in heater, formula, and DirtLifter PowerBrushes do the work for you.

Caution: Do not overwet. Take care not to run over loose objects or edges of area rugs. Stalling brush may result in premature belt failure.

Note: Your machine is equipped with a circuit breaker that will automatically shut off the brush if a large or loose object is caught in the brush roll. If that happens, be sure to unplug your machine, remove the foreign object, and then plug the machine back in to reset the circuit breaker.

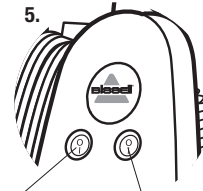
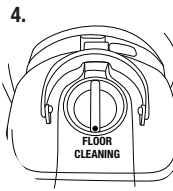
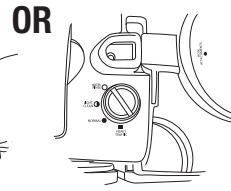
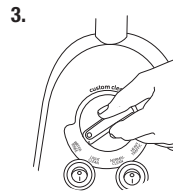
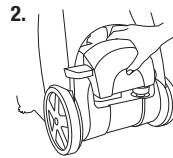
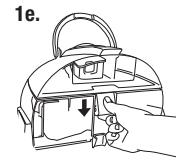

Power Switch Heater Switch

⚠ WARNING:
To reduce the risk of fire and electric shock due to internal component damage, use only BISSELL cleaning fluids intended for use with the deep cleaner.

Operation

Carpet cleaning (Continued)

6. (Continued) Release the trigger and make one slow forward and backward pass over the same area to remove any residual dirty water and aid in drying. Repeat cleaning passes until solution being pulled up appears clean. Continue passes without pressing the trigger until you can't see any more water being pulled up. After cleaning, you may want to turn the Custom Clean dial to rinse to give your carpeting a final water only rinse. This will ensure thorough removal of embedded dirt loosened by the deep cleaning formula. BISSELL deep cleaning formulas contain an anti-resoiling agent that helps your carpets repel dirt and keeps them looking good longer.

Keep plenty of genuine BISSELL Fiber Cleansing Formula™ on hand so you can clean whenever it fits your schedule. Always use genuine BISSELL deep cleaning formulas. Non-BISSELL cleaning solutions may harm the machine and void the warranty.

7. Remove the tank from the base of the machine by lifting up on the tank carry handle. Carry like a bucket to a utility sink or outside where you will dispose of the dirty water.

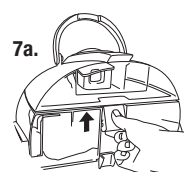
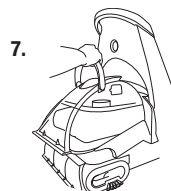

- 7a. Unlatch the top of the tank from the bottom by lifting up on the tank latch which is located on the back of the tank.

- 7b. Remove the top of the tank by lifting up on the handle.

Note how the lip on the top tank separates from the groove in the bottom tank. This placement is important when putting the tank back together.

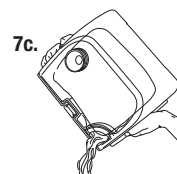
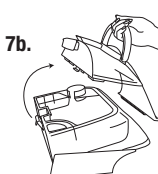

- 7c. Lift the bottom portion of the tank; pour out dirty water toward the sink through the triangular shaped opening in the corner of the tank.

Note: You may notice hair & debris deposits on the carpet or in the tank that were loosened by the cleaning action (especially with newer carpets that have never been deep cleaned before). This debris should be picked up and thrown away.

- 7d. Fill the heavy duty bladder with clean hot tap water, following instructions 1c through 1e on pages 9 and 10.

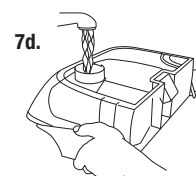

Note: Remember to secure the tank latch in the back and test to make sure it is secure before picking up the tank. Always check the level of cleaning formula in the formula tank at the same time, and refill as needed.

Operation

Carpet cleaning (Continued)

- 8. Water rinse (Optional).** Rinsing is an optional step that can be done during the cleaning process by switching from one of the clean settings on the Custom Clean dial to a water rinse setting, or it can be done after the carpeted area has been cleaned. Simply choose the water rinse setting on the custom clean dial, and follow the same path as you did for cleaning, taking care to do a forward (wet) stroke by depressing the trigger, a backward (wet) stroke, and a forward and backward (dry) stroke, releasing the trigger. Continue this until the water you see coming up the nozzle is clear.

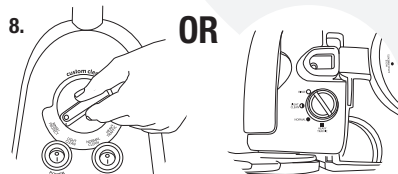

Cleaning with attachments

Your ProHeat 2X machine comes equipped with a hose and at least one attachment for cleaning stairs, upholstery, and more.

- 1. Important!** If using to clean upholstery, check upholstery tags.
 - A.** Check manufacturer's tag before cleaning. "W" or "WS" on the tag means you can use your ProHeat 2X. If the tag is coded with an "X" or an "S" (with a diagonal stripe through it), or says "Dry Clean Only", do not proceed with any deep cleaning machine. Do not use on velvet or silk. If manufacturer's tag is missing or not coded, check with your furniture dealer.
 - B.** Check for colorfastness in an inconspicuous place.
 - C.** If possible, check upholstery stuffing. Colored stuffing may bleed through fabric when wet.
 - D.** Plan activities to allow upholstery time to dry.
 - E.** Vacuum thoroughly to pick up loose debris and pet hair. Use a vacuum with a brush attachment and a crevice tool to clean in fabric folds.
- 2.** Follow the instructions on pages 9 & 10 for filling the 2-in-1 water tank and the formula tank.
- 3.** Set ReadyTools dial to the hose attachments setting. This will allow spray and suction from the hose.

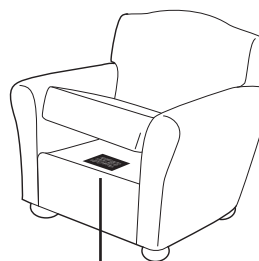

Manufacturer's tag

⚠ WARNING:
To reduce the risk of injury, be extra careful when cleaning stairs. Make sure machine is secure and level.

Operation

Cleaning with attachments (Continued)

4. Set custom clean dial for heavy traffic, normal clean, light clean, or water rinse as desired.
5. Attach the cleaning tool to the end of the hose.
6. Plug in and turn on the power switch and heater (if desired).
7. Clean by pressing the trigger to spray solution onto the area to be cleaned. Slowly move the tool back and forth over the soiled surface. Release the trigger to suction soiled water. Continue to clean in the area, working in small sections, until no more dirt can be removed. Rinse (optional) and suction as needed.
Caution: Do no overwet.
8. Remove and rinse tools in clean, running water. Dry and replace in the tool caddy.
9. It is recommended that you suction clean water from the tap to rinse out the hose.
10. Before replacing lift end of hose and stretch out to ensure all water is cleared from hose.
11. Coil flex hose around the tool caddy.
12. Empty 2-in-1 water tank and rinse out, following the instructions on page 11.
13. Return ReadyTools dial to floor setting.

5.

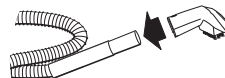

9.

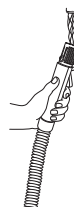

10.



WARNING:
To reduce the risk of fire and electric shock due to internal component damage, use only BISSELL cleaning fluids intended for use with the deep cleaner. Non-BISSELL cleaning solutions may harm the machine and void the warranty.

Cleaning fluid section

Keep plenty of genuine BISSELL Fiber Cleansing Formula™ on hand so you can clean and protect whenever it fits your schedule. Always use genuine BISSELL deep cleaning formulas.



48 oz. BISSELL
Fiber Cleansing
Formula™ with
Scotchgard™
Protector
#0710



48 oz. BISSELL
Multi- Allergen
Removal™ with
Scotchgard™
Protector
#0720



48 oz. BISSELL
Pet Odor and Soil
Removal™ Formula
with Scotchgard™
Protector
#0730



48 oz. BISSELL
Natural Orange
Extract Formula
with Scotchgard™
Protector
#0740



48 oz. BISSELL
Lavender Essence
Formula with
Scotchgard™
Protector
#0750



43 oz. BISSELL
3X Concentrated
Fiber Cleansing
Formula with
Scotchgard™
Protector
#0716



32 oz.
BISSELL
Hard Floor
Solutions™
Formula
#0484



22 oz.
BISSELL
Tough Stain
PreCleaner™
#0400



www.bissell.com

800.237.7691

13

Operations

Stain removal

Do Not Delay! Attending to an accident soon after it occurs ensures the most optimal clean. Leaving it for an extended period of time may cause it to set and become permanent.

1. Blot up liquids with an absorbent cloth or paper towels. White materials are recommended because certain dyes may bleed and make the stain worse.
2. Gently scrape up any semi-solids with a spoon or spatula. Do not use a knife or other utensil with sharp edges because it could damage the carpet or upholstery.
3. If the area has dried, remove the remaining semi-solids and residue with a sweeper or vacuum.
4. Be sure to test any spot removal formulas in an inconspicuous area first. This is important as some dyes and materials could be damaged or discolored by cleaning solvents. If such a change should occur, try a different solution or call a professional.
5. If cleaning on Berber carpeting, gently run your machine over a hidden area. If no fuzzing occurs, continue cleaning in soiled area.
6. Using the BISSELL Tough Stain PreCleaner, spray evenly over soiled area. Do not over-wet. Wait 3-5 minutes. Gently work the solution by blotting area with a clean, damp, color safe cloth.
7. Clean using either the **FLOOR CLEANING**, or **TOOLS** setting on the **ReadyTools dial**.



Operations

Hard floor cleaning

Your ProHeat 2X model may have come with a hard floor attachment and Hard Floor Solutions Formula. If not, these products are available for purchase by contacting the BISSELL Consumer Services department by phone or at the website. The hard floor tool provides effective cleaning for linoleum, vinyl, and tile floors.

Caution: Do not use on unsealed hardwood floors.

1. Vacuum or sweep thoroughly to pick up any loose debris and pet hair.
2. Move any furniture, if needed.
3. Empty any carpet cleaning formula back into the BISSELL bottle if stored in the formula tank. Fill formula tank with BISSELL Hard Floor Solutions, available at many retailers, or contact BISSELL Consumer Services.
4. Fill the 2-in-1 water tank with hot tap water and set aside.
5. Attach the hard floor tool onto the bottom of the machine by hooking it into the nozzle and swinging it down until it clicks into place.
6. Check **ReadyTools dial**. It should be set on floor cleaning.
7. Set the **Custom Clean dial** to normal clean.
8. Plug into an outlet and turn the power switch and heater **ON (I)**.
9. Slowly move the machine forward and back over hard floor surface one time while depressing trigger. **Caution: Do not overwet.**
10. Repeat the motion without pressing the trigger using the hard floor tool to squeegee and suction up the dirty water.
11. Allow adequate time for floors to dry.
12. Remove hard floor tool, rinse and dry before storing.
13. If any formula remains in the formula tank, pour it back into the Hard Floor Solutions bottle for use the next time.
14. Rinse out the formula tank.

⚠ WARNING:
To reduce the risk of fire, electric shock or injury unplug from outlet before servicing.

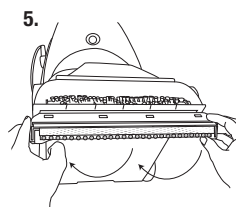

Maintenance and care



Machine storage

Once your cleaning is complete, make sure the 2-in-1 water tank is emptied, rinsed out, and dried before the next use. The formula tank can remain filled and ready to go, or it can simply be emptied back into the formula bottle if that is more convenient.

Note: Store cleaner in a protected, dry area. Since this product uses water, it must not be stored where there is a danger of freezing. Freezing will damage internal components and void the warranty.

Machine care

For best results, a few simple steps can assure your machine is well maintained after your cleaning is complete.

1. Turn power and heater switches OFF (O). Unplug the machine and wrap the power cord.
2. After emptying the 2-in-1 water tank, rinse it out at a faucet with running hot tap water, taking care to clean underneath the heavy duty bladder, and all around it.
3. The top half of the tank can be rinsed clean through the nozzle area. Also, pop out the red filter underneath the top half of the tank and rinse that out. Replace before putting the top and bottom halves of the tank together.
4. Before you place the cleaned 2-in-1 water tank back onto the machine, simply unscrew the floor nozzle using a Phillips head  screwdriver. This can be rinsed out at the faucet. Then replace back onto the machine by starting from the bottom of the nozzle and hooking the tabs into the holes on the bottom sides of the machine. Secure into place with the screw.
5. The inside of the end caps by the brush rolls can be wiped out with a clean paper towel, or, if a more thorough cleaning is desired, the end caps can be taken off using a Phillips head  screwdriver and rinsed clean. Replace after cleaning.
6. Any loose hair or debris can be pulled from the brush rolls and thrown away. For the most thorough clean before storage, follow directions on pages 17 & 18 for removal and replacement of the brush rolls and belts.

WARNING:
To reduce the risk of fire, electric shock or injury unplug from outlet before servicing.

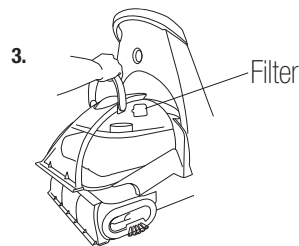

Tip:
Let all parts dry completely before storing

Maintenance and care

Machine care (continued)

7. To clean attachments that may have been used, remove from hose and rinse in clean, running water. Dry and replace attachment in the tool caddy. Clean the hose by suctioning clean water from the tap. Before replacing, lift end of hose and stretch out to ensure all water is cleared from hose. Refer to page 13, illustrations 9 & 10.
8. After carpet is dry, vacuum again to remove hair and fuzz.

Small belt removal and replacement

Occasional replacement of one or both belts may become necessary. If that is needed, please follow the instructions below.

1. Turn off the machine, and unplug it from the outlet.
2. Remove both the 2-in-1 water tank and the formula tank. Set aside.
3. Unscrew the front nozzle and remove it. Set aside.
4. Turn the machine on its side. **IMPORTANT: cord side down.**
5. Remove the clear end cap by unscrewing the 2 black screws. Take care not to drop the screws into the unit.
6. Remove 1 silver screw.
7. Remove pivot arm by gently lifting up.
8. Remove small brush belt.
9. Replace small brush belt, and reverse steps above.

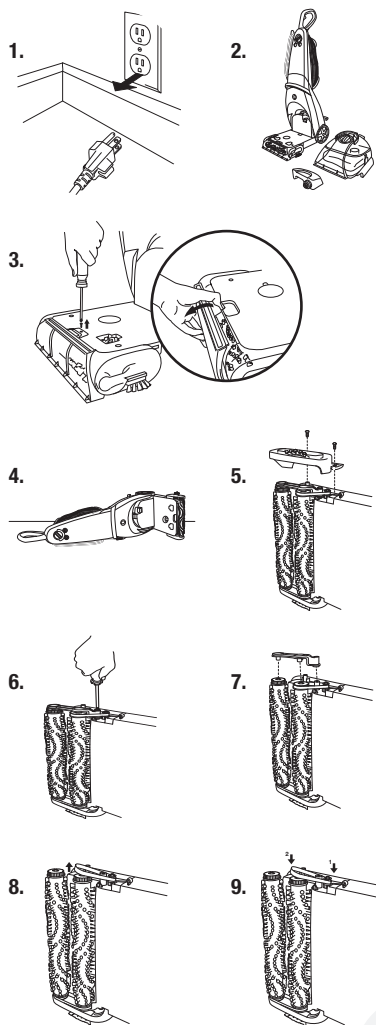

Maintenance and care

Brush removal and large belt replacement

Brushes can be removed for cleaning or replacement as needed.

1. Follow small belt removal Instructions on page 17.
2. Remove brush rolls by pulling them off of the metal rods.
3. Place cleaned or new brush rolls back onto the rods. Make sure one washer is on each end of the rollers prior to sliding onto the rod. Be sure to let the rod slide through the bushing to insure proper fit.
4. Re-attach the long belt on the bottom to the cogs of the small roller brushes.
5. Place small belt over back roller and metal cog.
6. Place pivot arm in place and screw in place using the silver screw.
7. Re-attach clear end cap by tightening with the (2) black screws.
8. Return front nozzle to front of unit, be latching from underneath and then securing with a screw.

If you have any questions or are having trouble installing or replacing your belt(s) or brushes, please call **BISSELL Consumer Services at 1-800-237-7691**.

⚠ WARNING:
To reduce the risk of fire, electric shock or injury, unplug from the outlet before servicing.

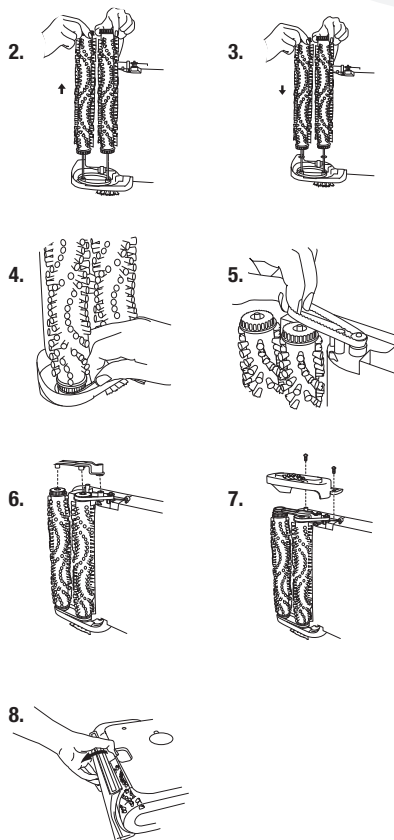

Troubleshooting

WARNING:
To reduce the risk of fire,
electric shock or injury
unplug from outlet before
servicing.

Built-in heater ready light does not illuminate

Possible Cause

1. The heater switch is not turned **ON (I)**.
2. The power switch is not turned **ON (I)**.

Remedies

1. Turn the heater switch **ON (I)**.
2. Both switches must be **ON (I)** to activate the heater ready light.

Reduce Spray or No Spray

Possible Cause

1. Water tank may be empty.
2. Formula tank may be empty.
3. Tank may not be seated completely.
4. Pump may have lost prime.

Remedies

1. Fill heavy duty bladder with hot tap water.
2. Fill formula tank with BISSELL Fiber Cleansing Formula for cleaning.
3. Turn power **OFF (O)**. Remove and reseal tank.
4. Turn power **OFF (O)** and then back **ON (I)**. Wait one minute, then depress Trigger.

DirtLifter PowerBrushes do not turn

Possible Cause

1. The brush is off or broken.
2. The unit is in the upright position.
3. Circuit breaker may have tripped.

Remedies

1. Turn power **OFF (O)** and unplug unit from outlet. Follow instructions on page 17.
2. Brushes only rotate when unit is reclined using the detent pedal.
3. Turn the machine **OFF (O)** and unplug from outlet. Check to see if foreign object is caught in brush roll. Remove object. Plug machine back in to reset circuit breaker.



Troubleshooting

Cleaner not picking up solution

Possible Causes

1. ReadyTools dial may be at wrong setting.
2. Tank may not be seated properly.
3. Tank may not be assembled properly.
4. Solution or 2-in-1 water tank is empty.
5. 2-in-1 water tank has picked up maximum dirty water and red float door has closed.
6. Red float "door" in the tank may have closed as a result of bumping an object or moving machine back and forth too quickly.

Remedies

1. Set ReadyTools dial to either FLOOR CLEANING or TOOLS setting.
2. Pick up both the 2-in-1 water tank and formula tank and reseal them so they fit snugly on the unit.
3. Check to make sure the "lip" of the nozzle is securely hooked into the groove on bottom of Tank (see page 9).
4. Check fluid levels in heavy duty bladder and formula tank.
5. Empty 2-in-1 water tank. Refill heavy duty bladder with clean hot tap water and replace.
6. Turn the machine **OFF** (), allowing red float door to release into the open position. Turn unit back **ON** () to continue cleaning. Be sure your forward and backward strokes are done at a slower pace.

Other maintenance or service not included in the manual should be performed by an authorized service representative.

Thank you for selecting a BISSELL product.

Please do not return this product to the store.

**For any questions or concerns, BISSELL is happy to be of service.
Contact us directly at 1-800-237-7691.**

BISSELL Consumer Services

For information about repairs or replacement parts, or questions about your warranty, call:

BISSELL Consumer Services
1-800-237-7691

Monday - Friday 8 a.m. — 10 p.m. EST

Saturday 9 a.m. — 8 p.m. EST

Or write:

BISSELL HOMECARE, INC

PO Box 3606

Grand Rapids MI 49501

ATTN: Consumer Services

Or visit the BISSELL website - **www.bissell.com**

When contacting BISSELL, have model number of unit available.

Please record your Model Number: _____

Please record your Purchase Date: _____

NOTE: Please keep your original sales receipt. It provides proof of date of purchase in the event of a warranty claim. See Warranty on page 24 for details.

Please register your new BISSELL product at
www.bissell.com/productregistration

Replacement parts - BISSELL ProHeat 2X

Item	Part No.	Part Name
1	203-6611	Grey Tank Assembly (complete) for Black unit (Blue or Purple complete tank assemblies available upon request)
2	203-6660	Grey Tank Lid (Blue or Purple Tank Lids available upon request)
3	203-6618	Grey Tank Bottom (Blue or Purple Tank Bottoms available upon request)
4	203-6675	Cap and Insert for Water Tank
5	203-6676	Formula Tank (includes Cap & Insert for Formula Tank)
6	203-6677	Cap and Insert for Formula Tank
7	203-6678	Front Nozzle (includes gasket)
8	203-6679	Autoload Gasket (fits both Water and Formula Tank)
9	203-6845	Float Door
10	203-6680	Tank Filter (Lint Screen)
11	203-6681	Water Tank Latch
12	203-6682	Cord Wrap (Black) (Blue or Purple cord wrap available upon request)
13	203-6685	Clear End Cap w/Edge Brushes (2 pack, includes screws)
14	203-6686	Brush Roll – 6 row (includes 1 brush, axle, 2 swivel arms)
15	203-6688	Small Brush Belt (non-cord side)
16	203-6804	Large Brush Belt (cord side)
17	203-6689	Hose Secure Latch
18	203-6690	Hose Rack Assembly (Top/Bottom Hose Rack, Screws)

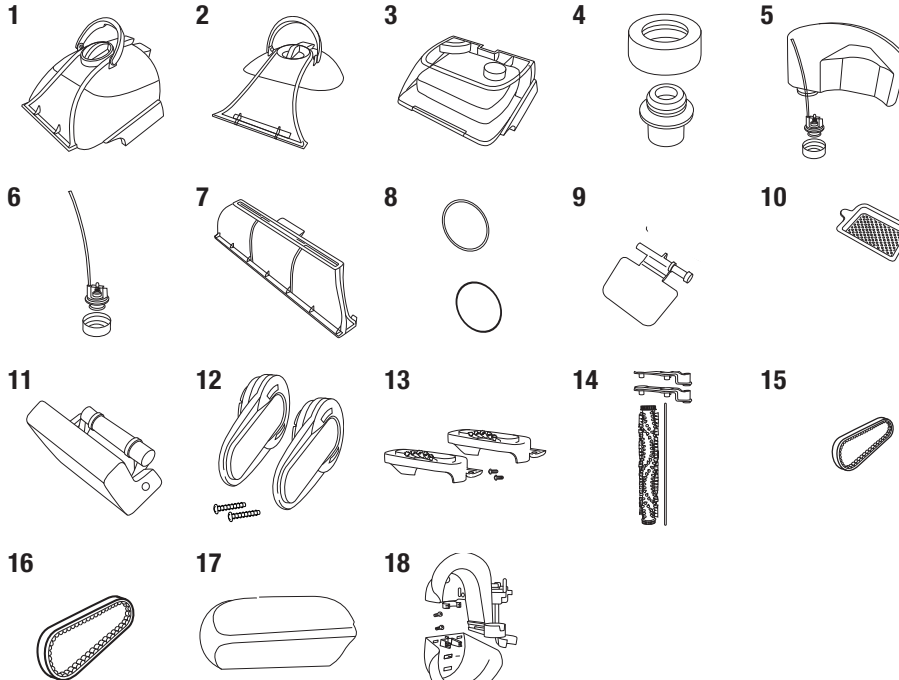

Additional accessories

These items are available for purchase as accessories for your BISSELL ProHeat 2X:
To purchase call 1-800-237-7691 or visit www.bissell.com.

Item	Part No.	Part Name
1	203-6651	3" Tough Stain Tool
2	203-6652	Powered TurboBrush Hand Tool
3	203-6653	4" Upholstery Tool
4	203-6654	6" Stair Tool
5	203-6655	Spraying Crevice Tool
6	203-6692	Bare Floor Tool

1

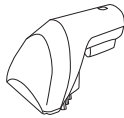

2

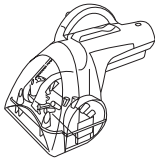

3

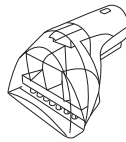

4

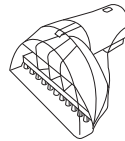

5



6

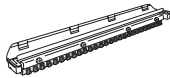

Cleaning Formula: Refer to bottom of page 5 of this guide for a full selection of cleaning formula available for purchase.

For a complete list of replacement parts, cleaning formulas, and accessories available for your BISSELL deep cleaner please visit www.bissell.com or contact BISSELL Consumer Services at 800.237.7691.

Earn Rewards Points!

To qualify you for discounts, rebates, and other BISSELL perks.
Visit www.bissell.com/rewards to learn more.

Warranty - BISSELL ProHeat 2X

This warranty gives you specific legal rights, and you may also have other rights which may vary from state to state. If you need additional instruction regarding this warranty or have questions regarding what it may cover, please contact BISSELL Consumer Services by E-mail, telephone, or regular mail as described below.

Limited One Year Warranty

Subject to the ***EXCEPTIONS AND EXCLUSIONS** identified below, upon receipt of the product BISSELL Homecare, Inc. will repair or replace (with new or remanufactured components or products), at BISSELL's option, free of charge from the date of purchase by the original purchaser, for one year any defective or malfunctioning part.

See information below on "If your BISSELL product should require service".

This warranty applies to product used for personal, and not commercial or rental service. This warranty does not apply to fans or routine maintenance components such as filters, belts, or brushes. Damage or malfunction caused by negligence, abuse, neglect, unauthorized repair, or any other use not in accordance with the User's Guide is not covered.

If your BISSELL product should require service:

Contact BISSELL Consumer Services to locate a BISSELL Authorized Service Center in your area.

If you need information about repairs or replacement parts, or if you have questions about your warranty, contact BISSELL Consumer Services.

Website or E-mail:

www.bissell.com

Use the "Customer Services" tab.

Or Call:

BISSELL Consumer Services

1-800-237-7691

Monday - Friday 8 a.m. - 10 p.m. ET

Saturday 9 a.m. - 8 p.m. ET

Or write:

BISSELL Homecare, Inc.

PO Box 3606

Grand Rapids MI 49501

ATTN: Consumer Services

BISSELL HOMECARE, INC. IS NOT LIABLE FOR INCIDENTAL OR CONSEQUENTIAL DAMAGES OF ANY NATURE ASSOCIATED WITH THE USE OF THIS PRODUCT. BISSELL'S LIABILITY WILL NOT EXCEED THE PURCHASE PRICE OF THE PRODUCT.

Some states do not allow the exclusion or limitation of incidental or consequential damages, so the above limitation or exclusion may not apply to you.

***EXCEPTIONS AND EXCLUSIONS FROM THE TERMS OF THE LIMITED WARRANTY**

THIS WARRANTY IS EXCLUSIVE AND IN LIEU OF ANY OTHER WARRANTIES EITHER ORAL OR WRITTEN. ANY IMPLIED WARRANTIES WHICH MAY ARISE BY OPERATION OF LAW, INCLUDING THE IMPLIED WARRANTIES OF MERCHANTABILITY AND FITNESS FOR A PARTICULAR PURPOSE, ARE LIMITED TO THE ONE YEAR DURATION FROM THE DATE OF PURCHASE AS DESCRIBED ABOVE.

Some states do not allow limitations on how long an implied warranty lasts, so the above limitation may not apply to you.



©2008 BISSELL Homecare, Inc.
Grand Rapids, Michigan
All rights reserved. Printed in China
Part Number 120-4054
Rev 9/08
Visit our website at:
www.bissell.com

Scotchgard is a trademark of 3M

